

# Finding Your Way

Jim Lengel



CHRISTOFEL COLONUS.

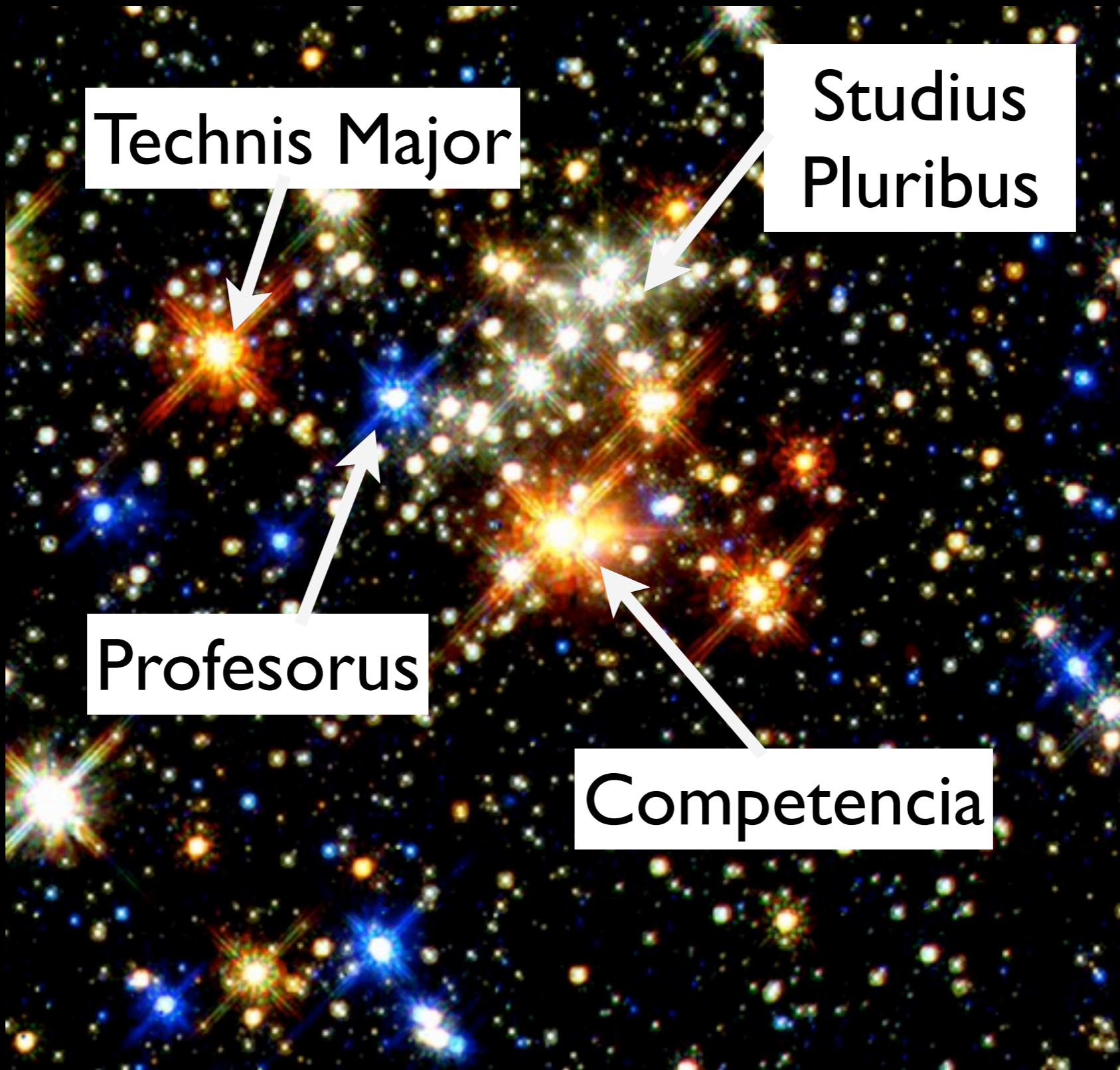

Photo # NH 92607 VAdm. J.S. McCain & Cdr. J.S. McCain, Jr. at end of WWII



SAILING - CANTORAMA B&O / SKIFFER - ELLEN MACARTHUR (GB) - ELLEN ON BOARD OF HER NEW 75 FOOT REMARAN - SYDNEY (AUG) - 31 /12/2003  
PHOTO - ANDREA FRANCOUZI / DDPY / OFFSHORE CHALLENGES





Technis Major

Studius Pluribus

Profesorus

Competencia

Technis Major

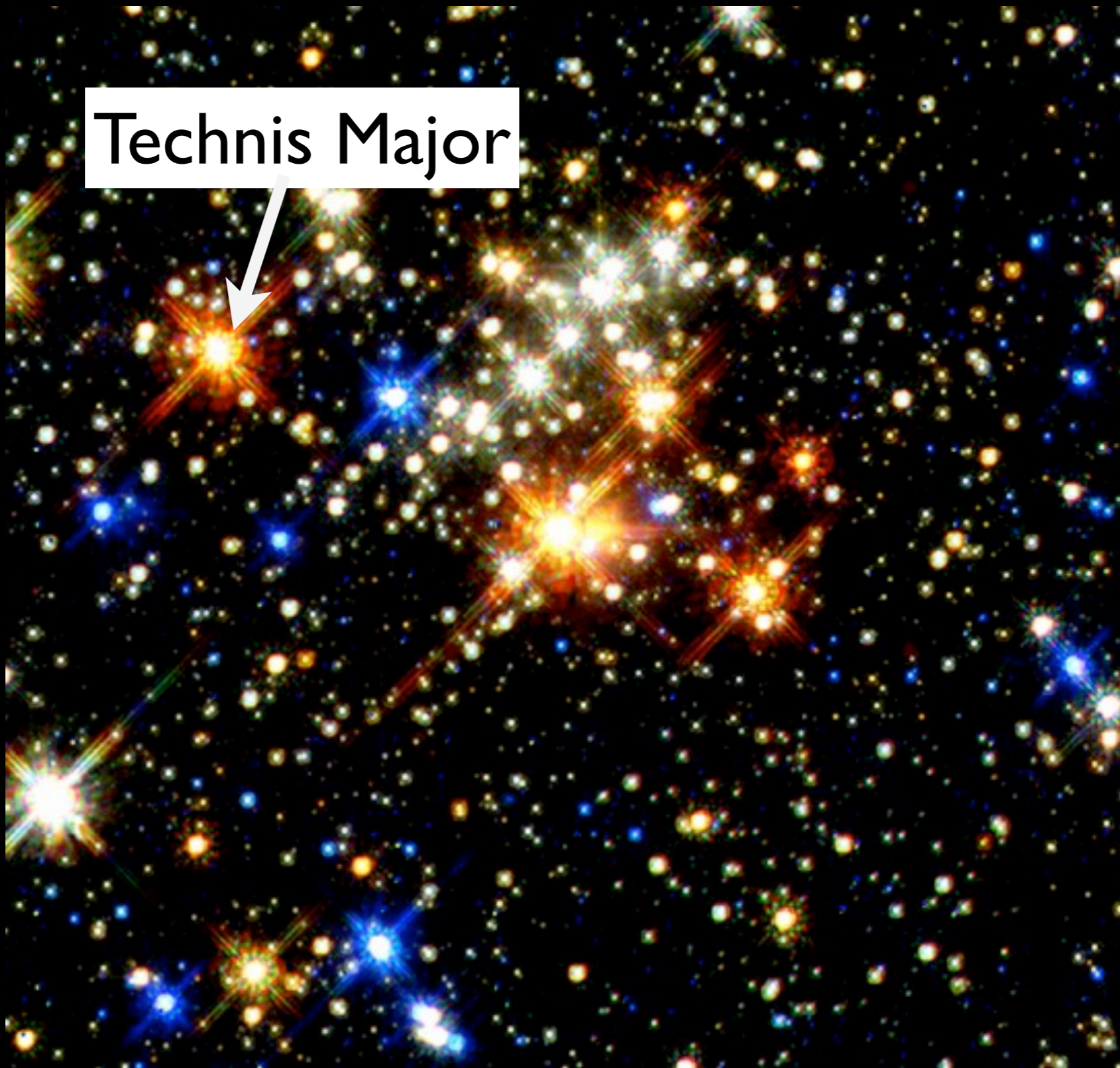



**Microsoft®**



**YAHOO!®**



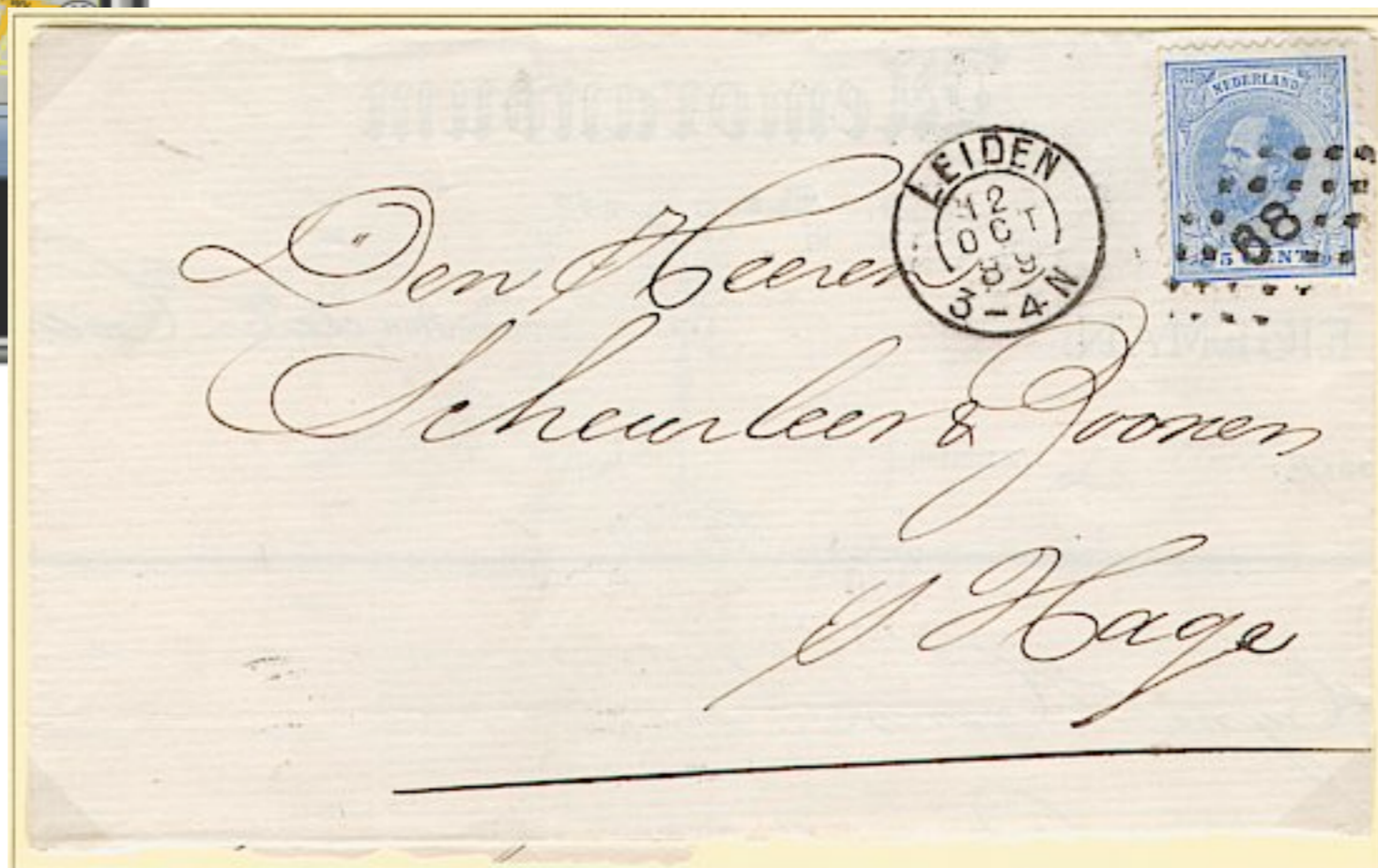
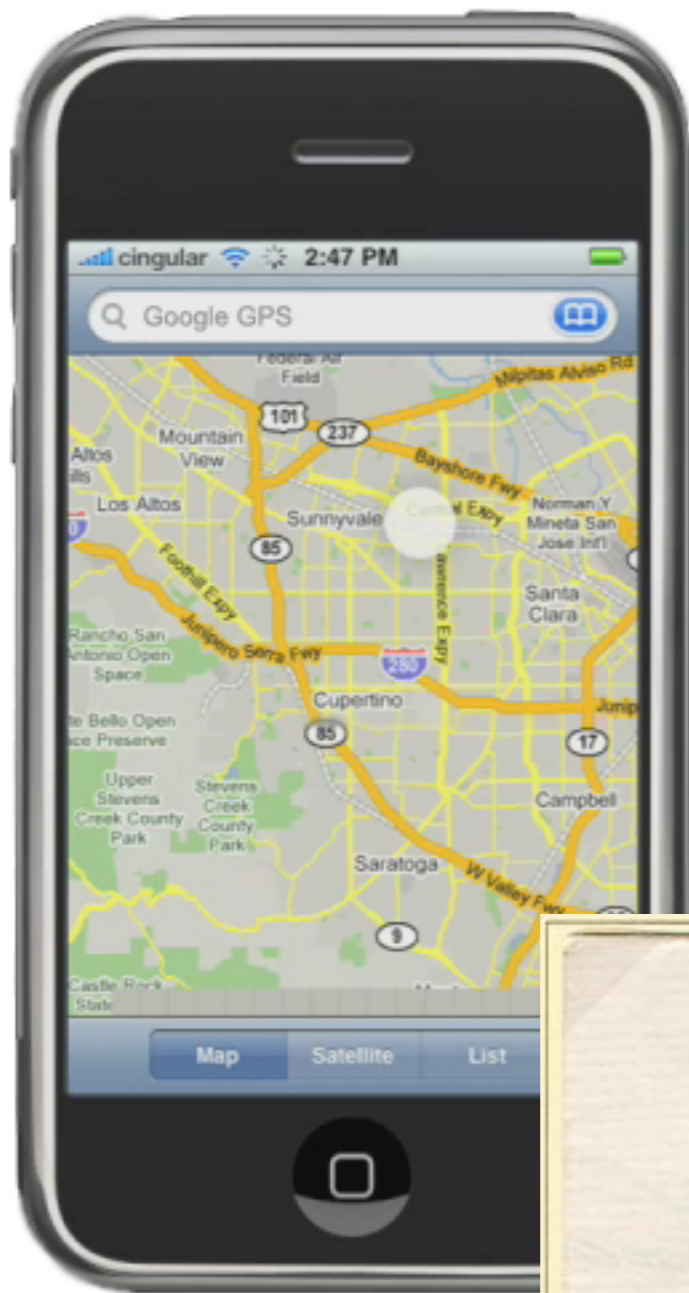

Technis  
Major



**productive**

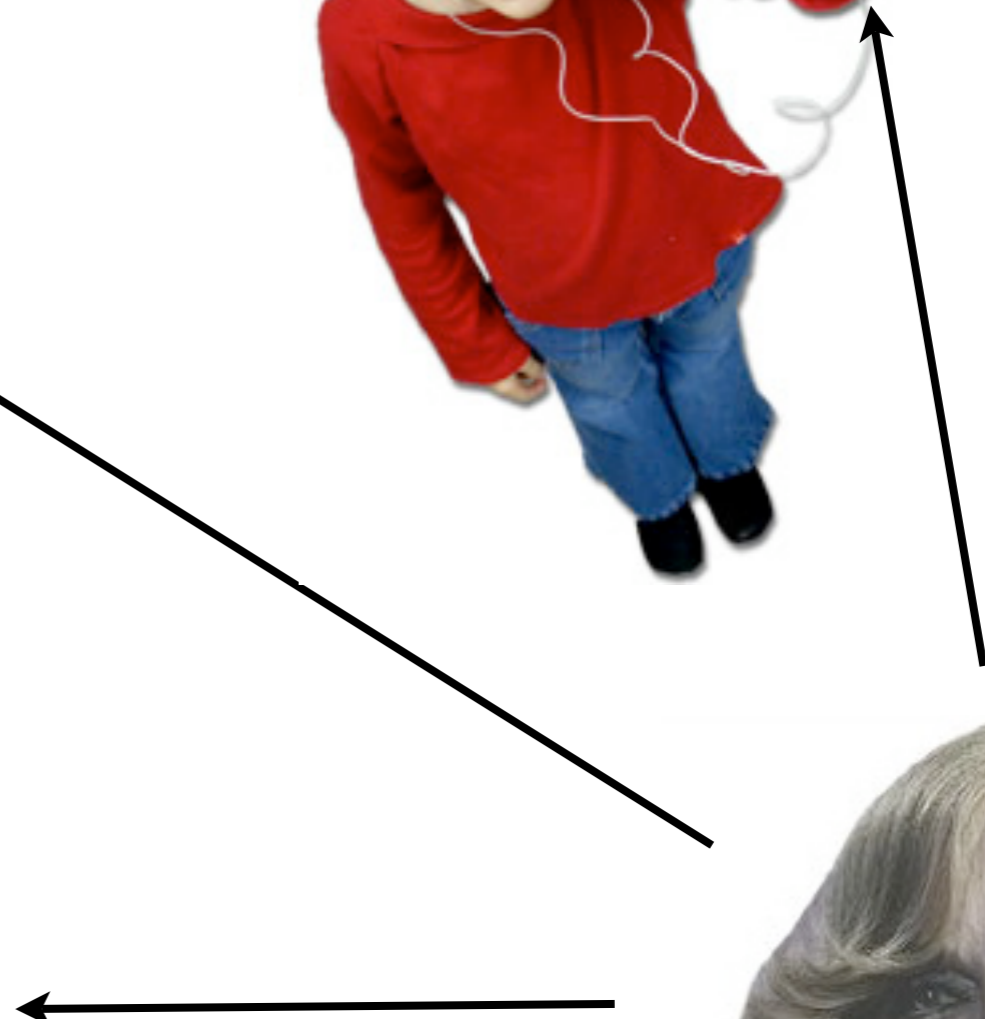
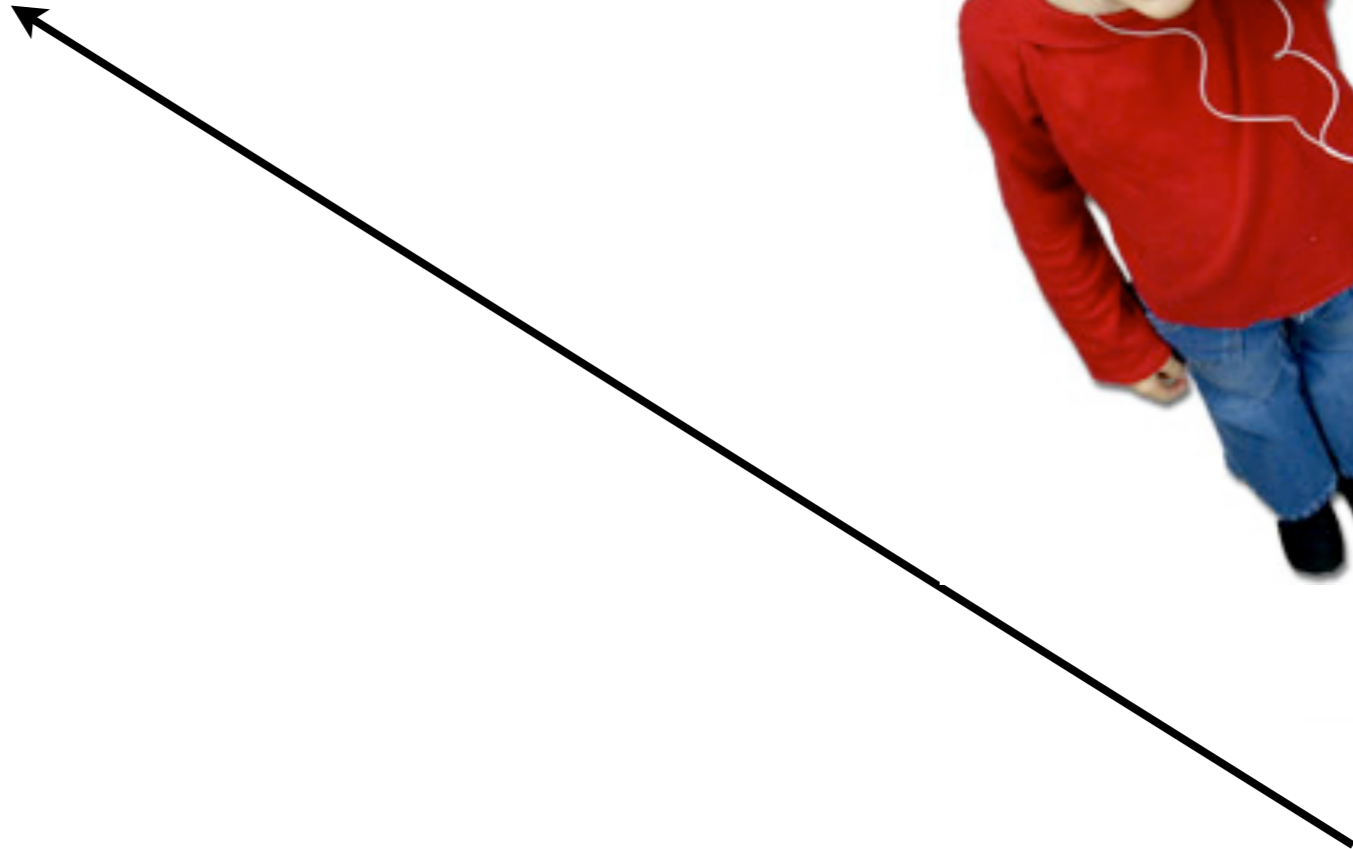

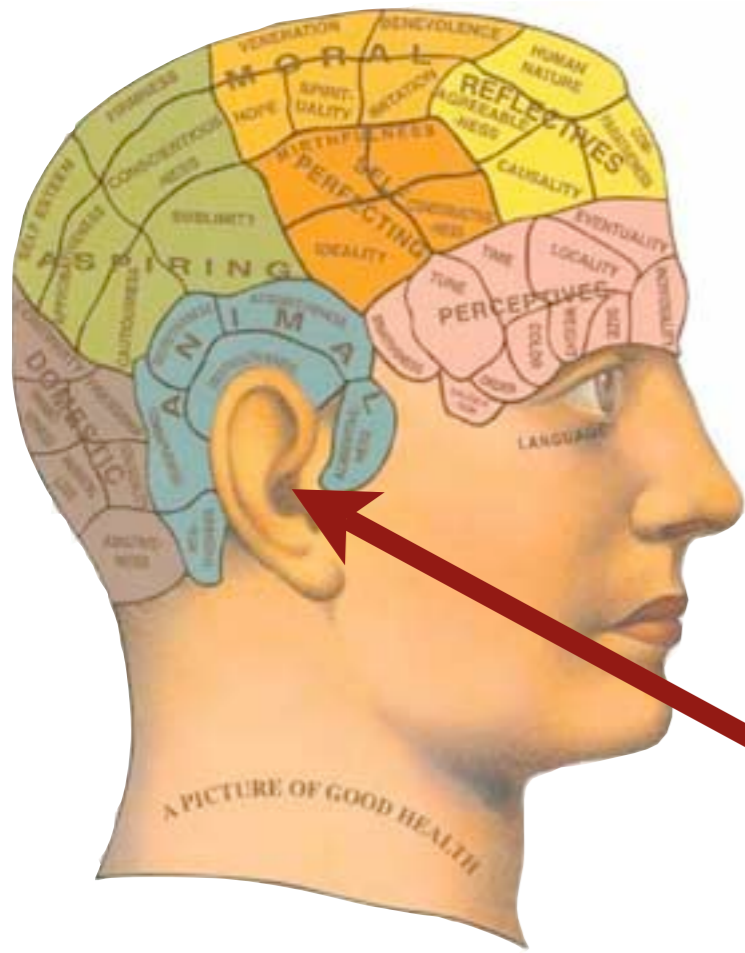

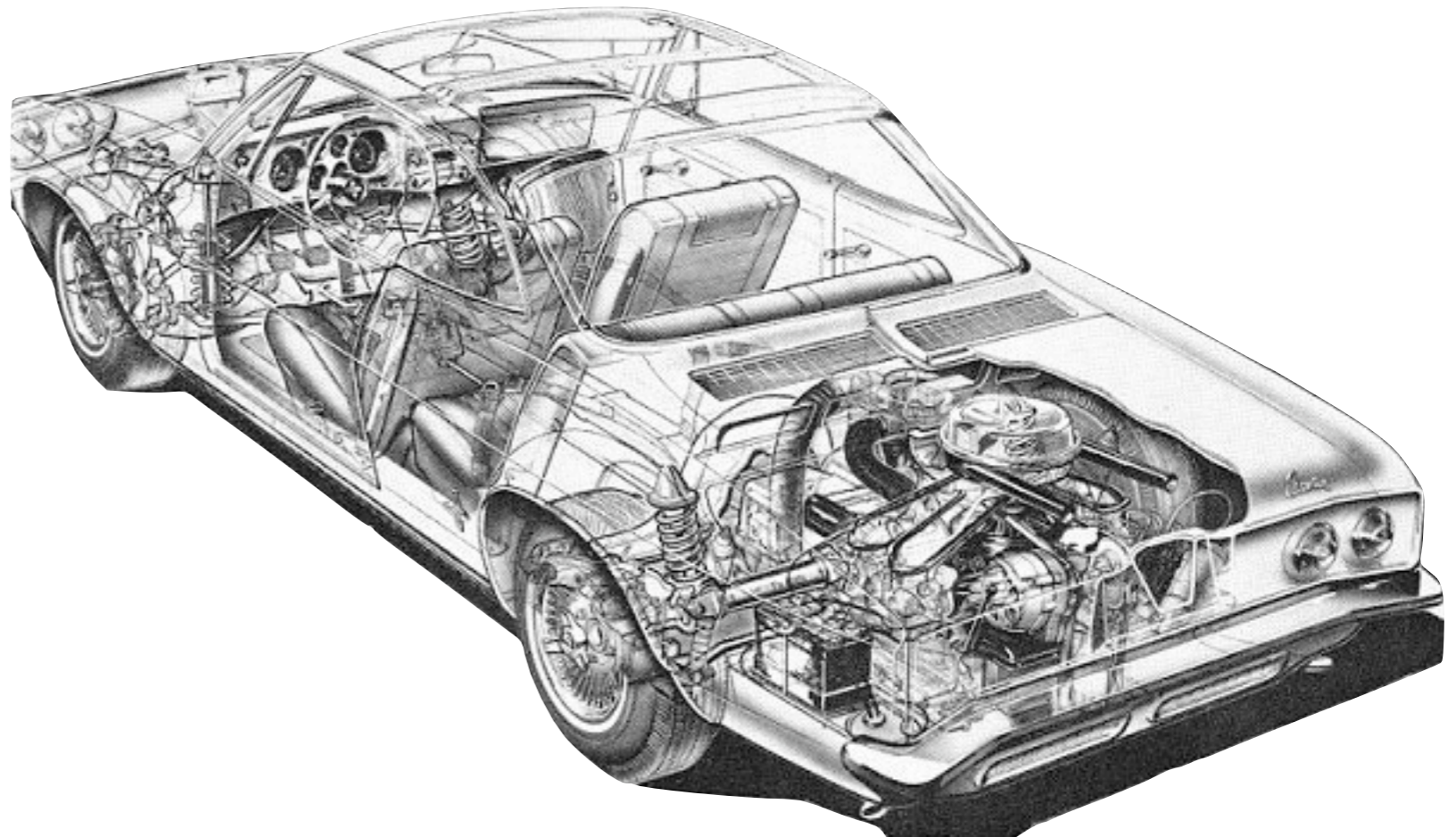

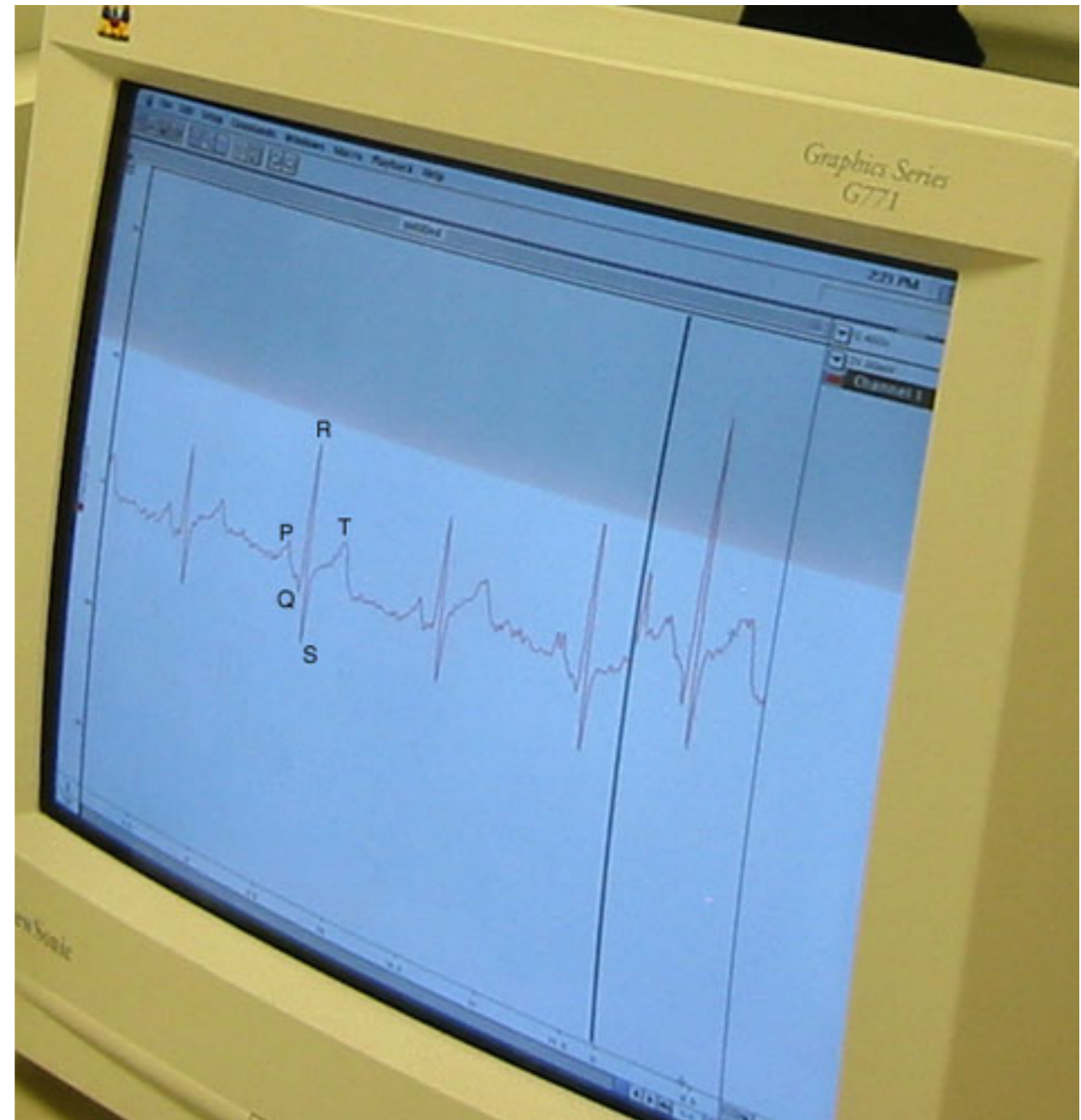

## Participating Countries



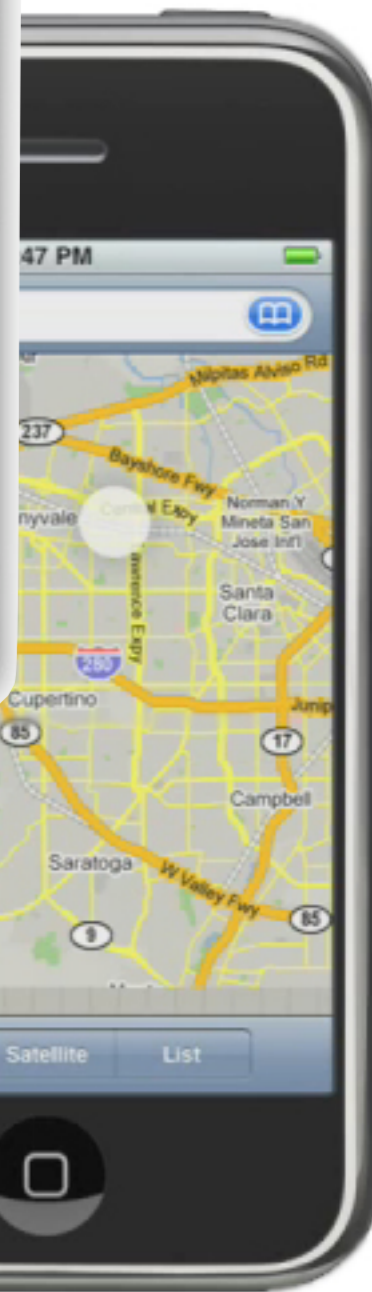

Technis  
Major



**communicate**



Google™

Chart - North Up Mercator Soundings: Feet



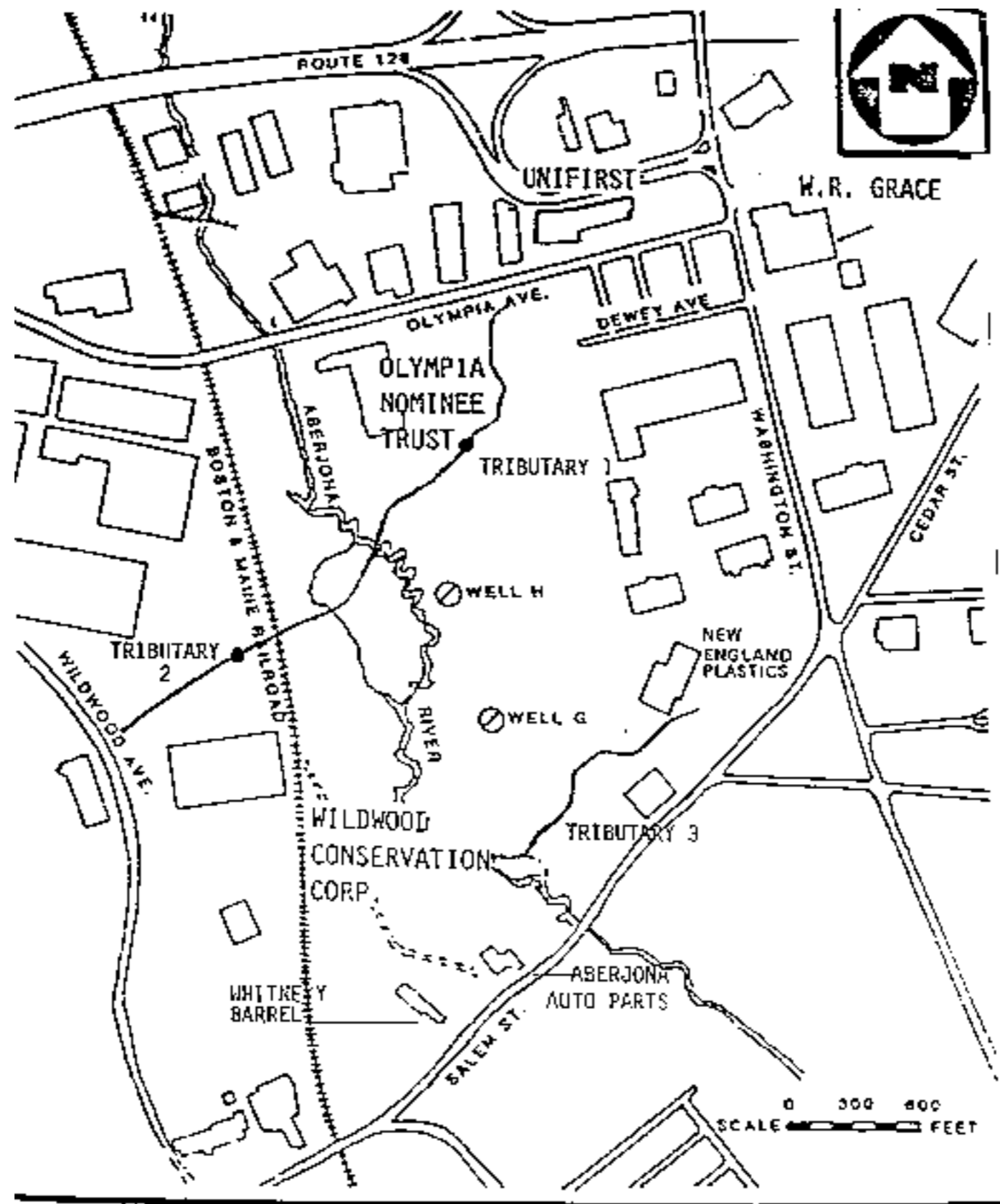
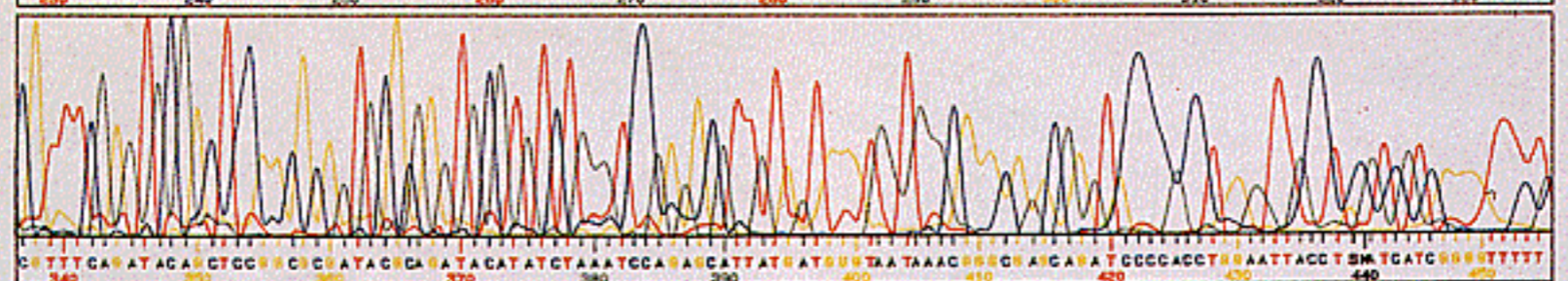
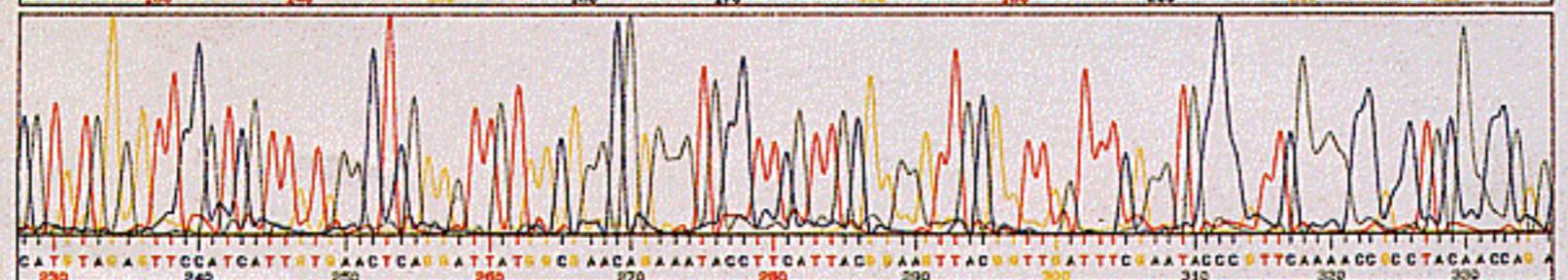
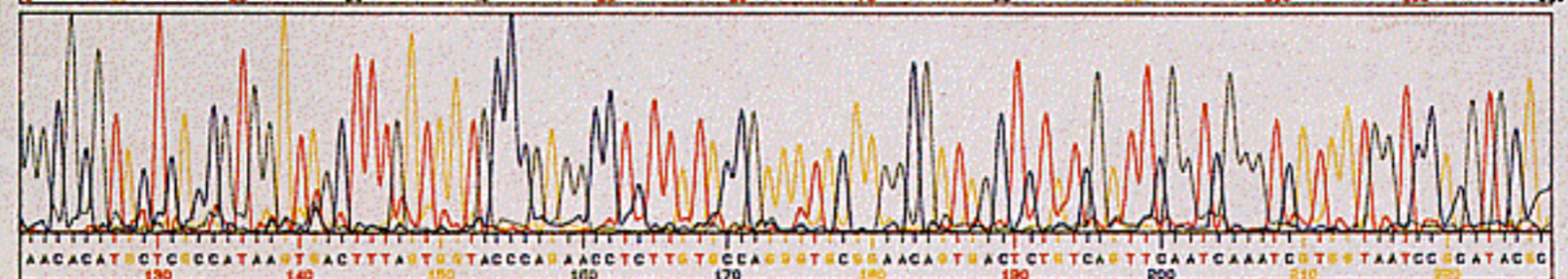
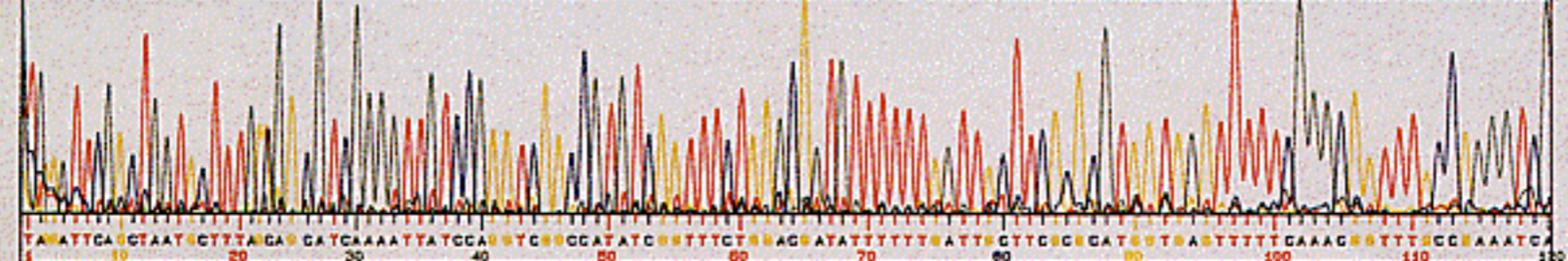

FIGURE 2: SITE MAP FOR WELLS G&H, WOBURN, MA.

BASE MAP SOURCE:  
 NUS REMEDIAL INVESTIGATION REPORT  
 WELLS G&H SITE  
 OCTOBER, 1986



Technis  
Major



research



Technis  
Major



media

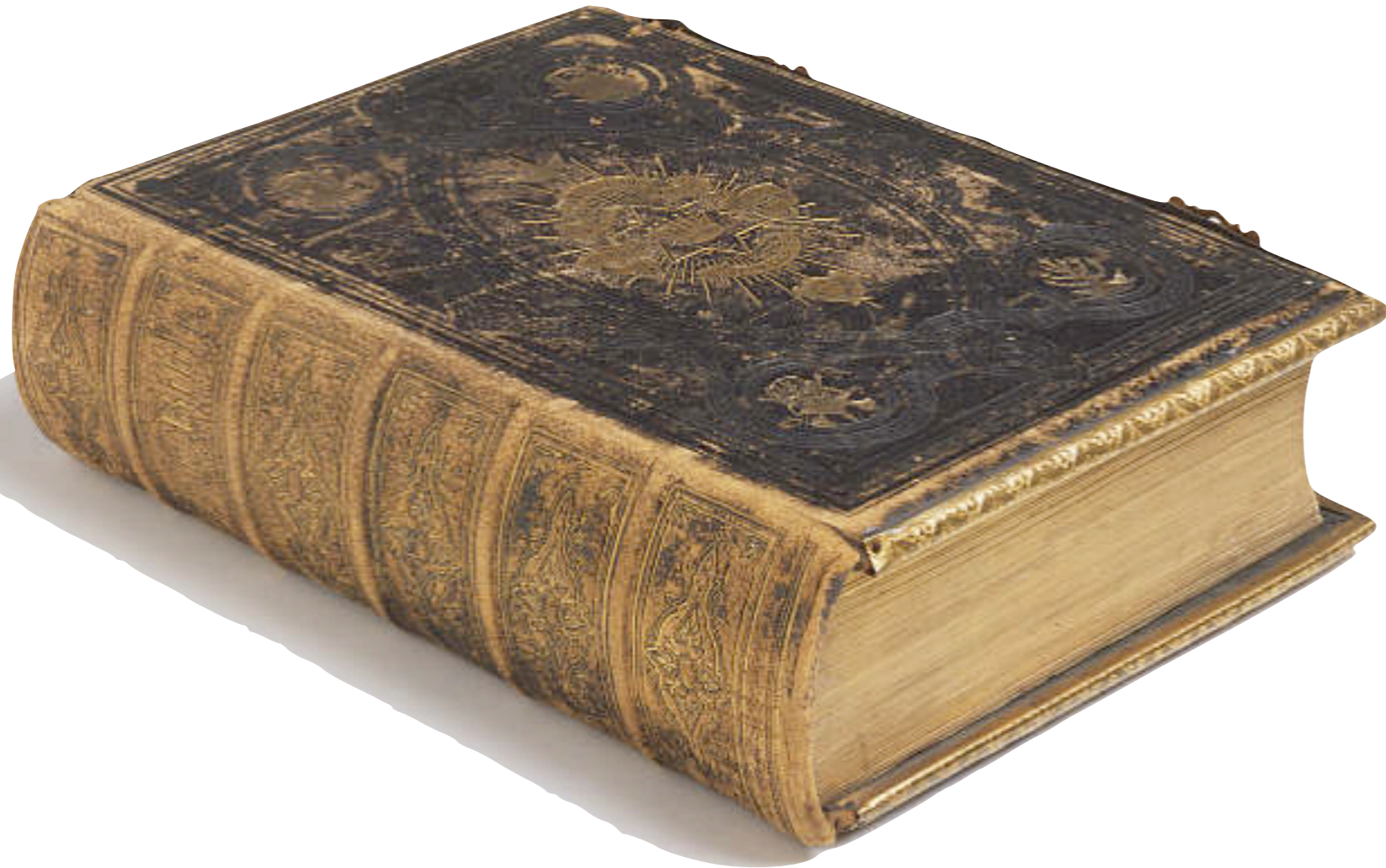



You



Broadcast Yourself



## Grassroots Video

Technis  
Major



**publish**





# Technis Major

and you

- productive
- communicate
- research
- publish

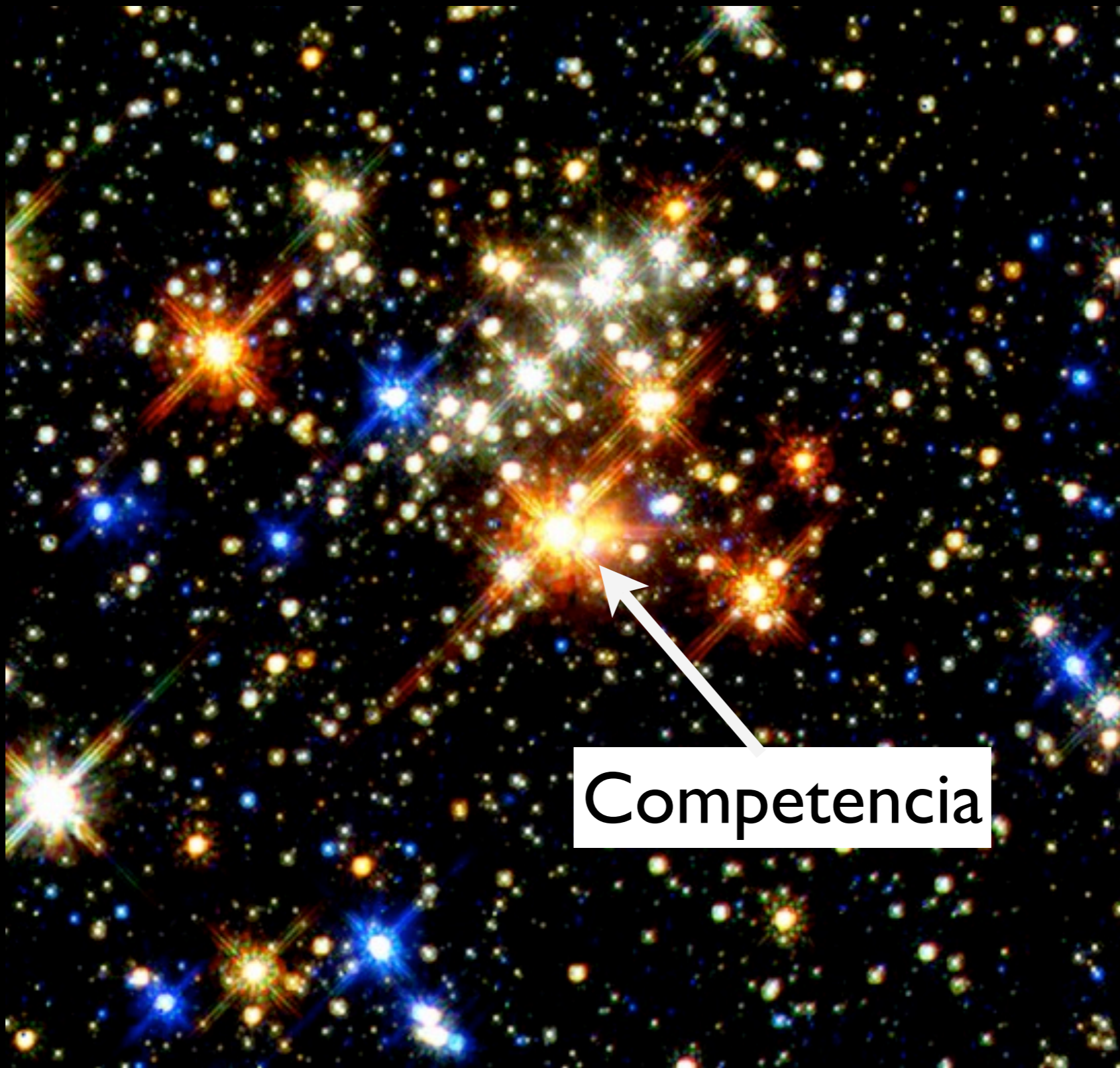

Competencia

Google™



CISCO



Liberty  
Mutual™



# Savage Chickens

by Doug Savage



[www.savagechickens.com](http://www.savagechickens.com)



**WORK**  
*Lessons and Examples*  
**SMART**  
*on How to Succeed*  
**AND**  
*in Your Career*  
**SUCCEED**

*Jeff Rosenblum*



## GDP per hour worked

2006, \$ at PPP\*

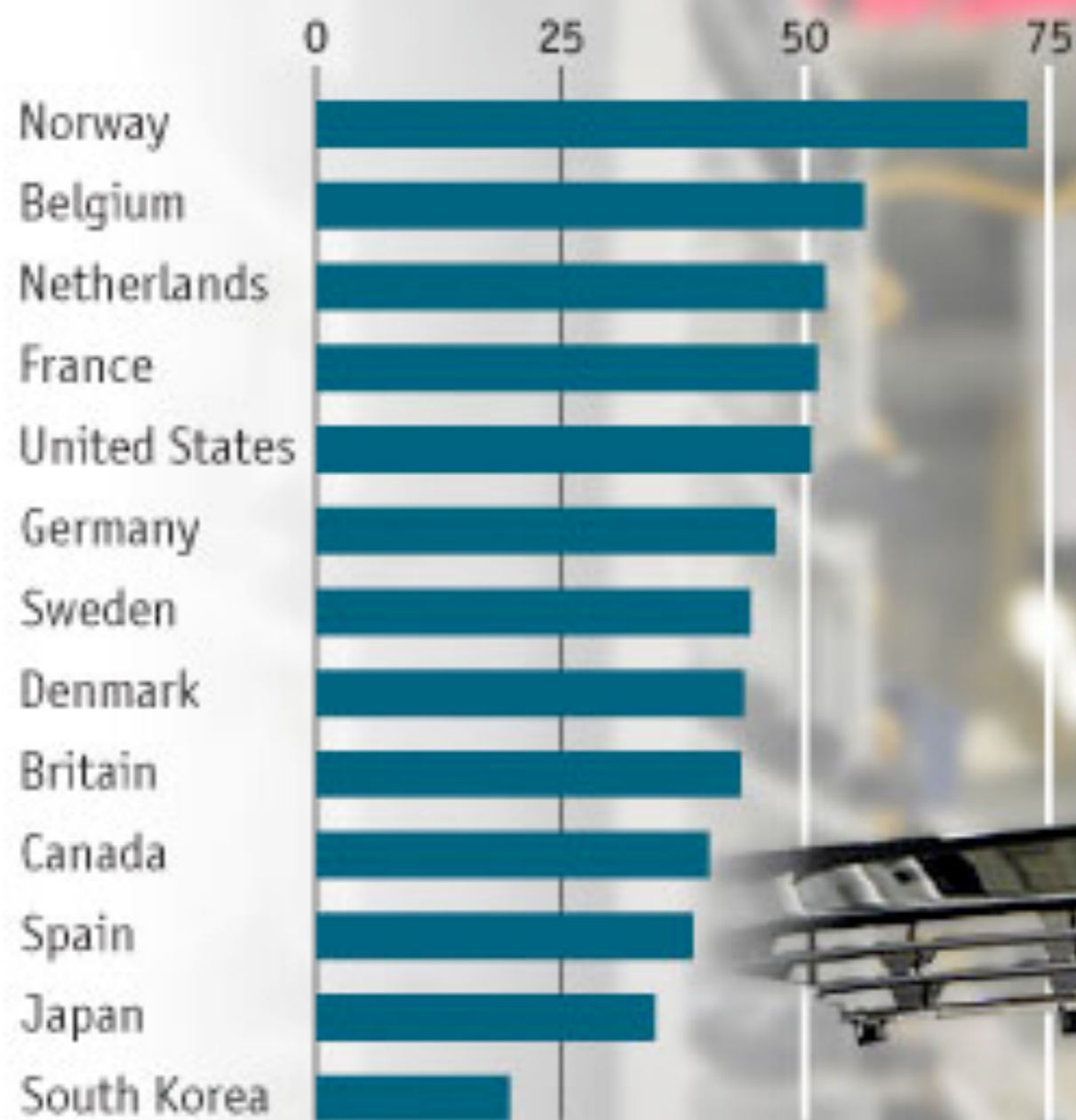

Source: Bureau of Labour Statistics

\*Purchasing-power parity



Competencia



**productive**







Competencia



**communicate**



Competencia



research

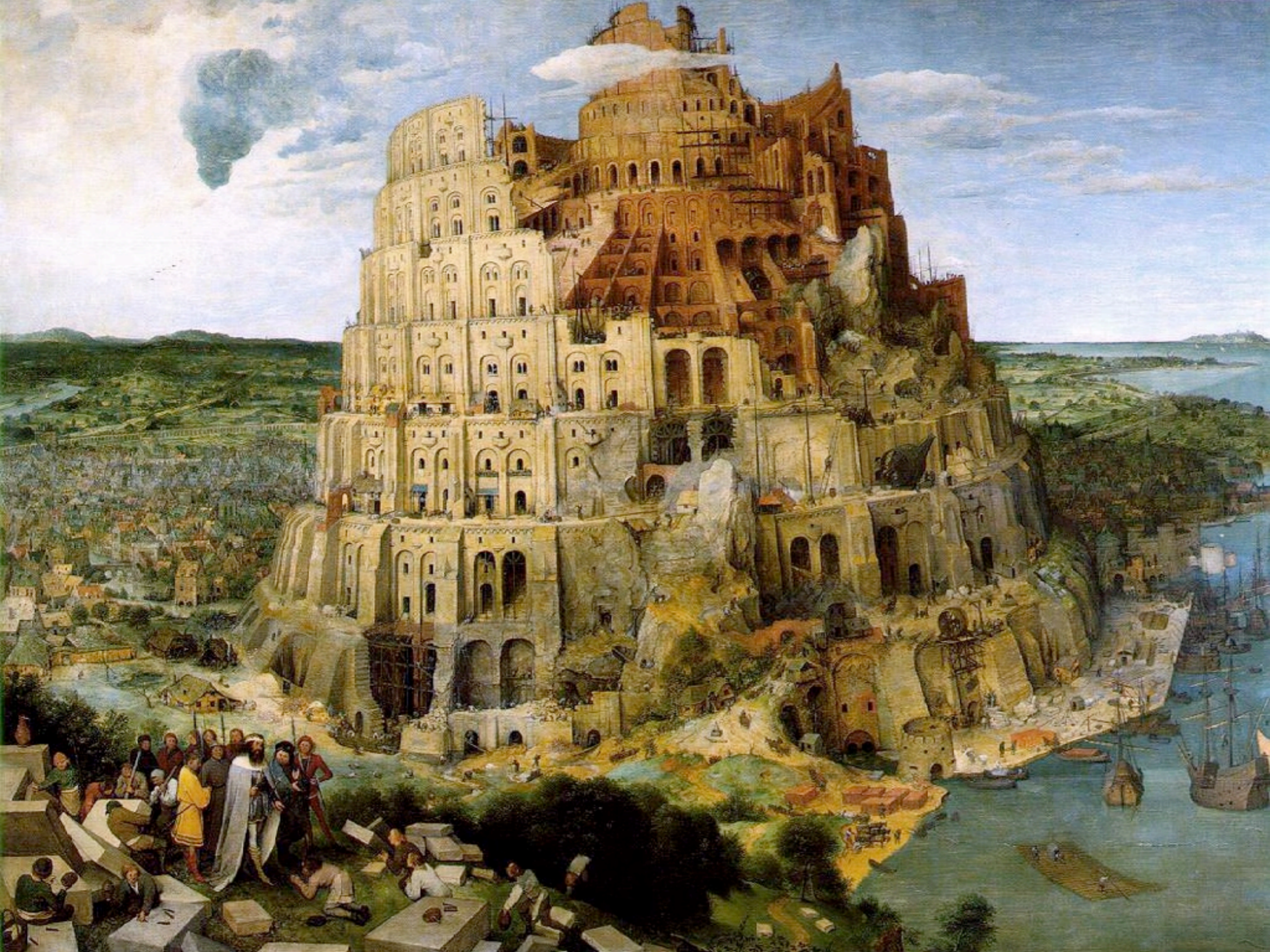

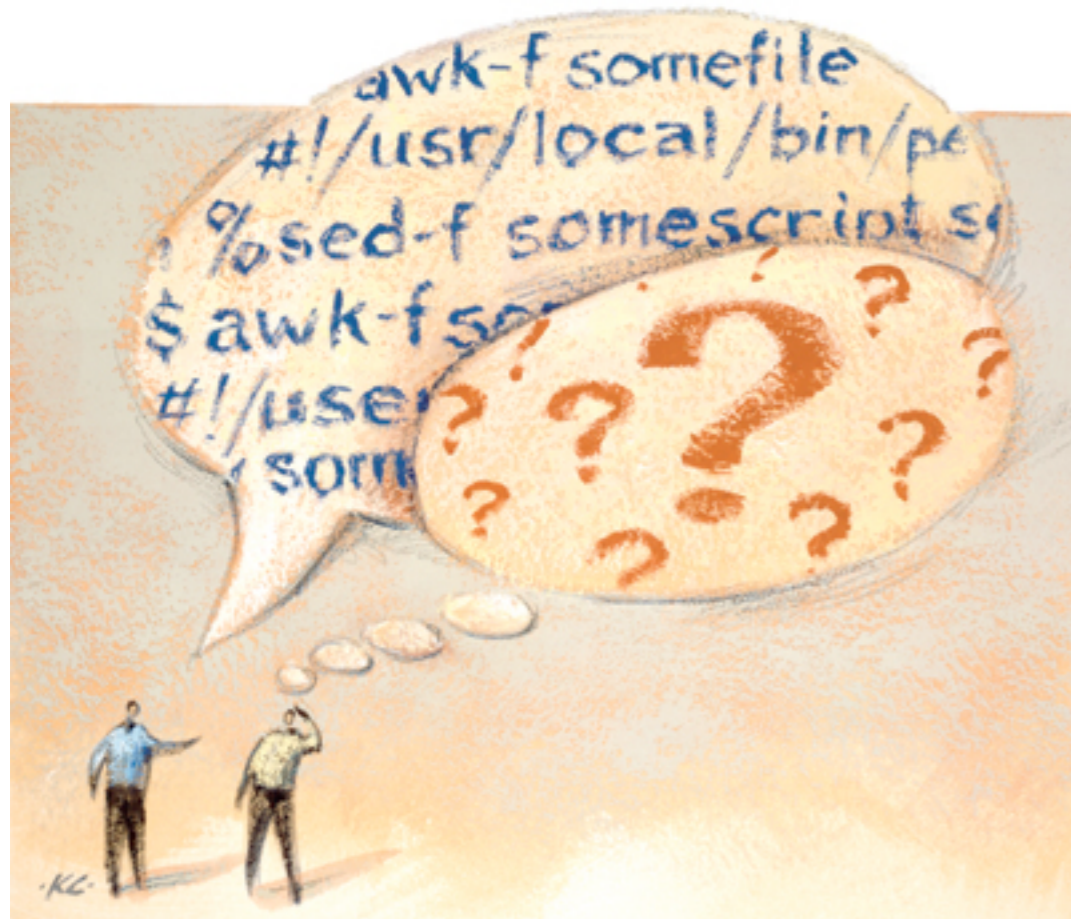

$$\text{Max } F_{3v}(L, y) \left[ \frac{C_3(L, y)}{P} - 1 \right]$$

YES

$$\text{Subject to } \frac{\partial F_{iv}}{\partial x} = -J_{iv}$$

$$\frac{\partial (F_{iv} C_i)}{\partial x} = -J_{is}$$

$$i = 1, 2, 3, 4$$





Competencia



media

## Containment Structure

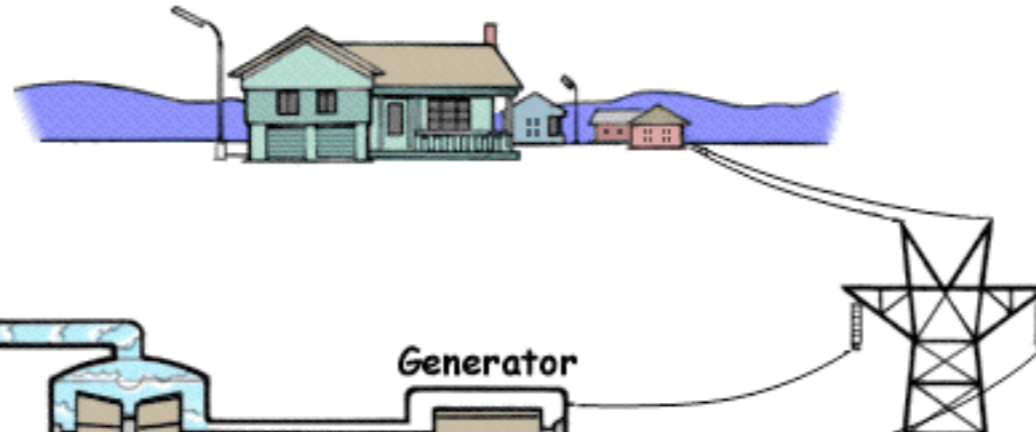
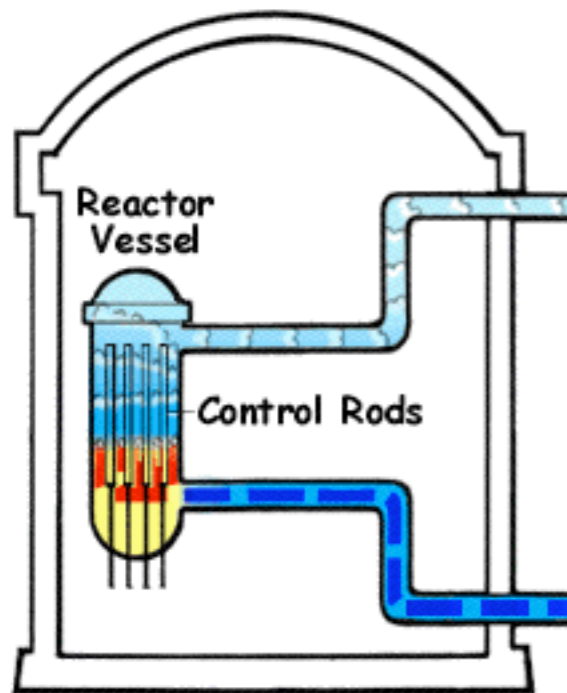

# Report Card & Key Findings

Our ratings for the 25 sites plus key findings

- = Good (1 point)
- ◐ = OK (0 points)
- = Poor (-1 points)

|                   | page | Accuracy/Relevance | Misspelled Search Term(s) | Mixed Specifications | Synonyms and Related Terms | Sorting/Filtering Results | No Results Found | Overall Score |
|-------------------|------|--------------------|---------------------------|----------------------|----------------------------|---------------------------|------------------|---------------|
| Lands' End        | 23   | ●                  | ●                         | ●                    | ●                          | ●                         | ●                | 5             |
| Petco             | 28   | ●                  | ●                         | ●                    | ●                          | ●                         | ●                | 5             |
| Drugstore.com     | 19   | ●                  | ○                         | ●                    | ●                          | ●                         | ●                | 4             |
| KBToys.com        | 22   | ●                  | ○                         | ●                    | ●                          | ●                         | ●                | 4             |
| L.L. Bean         | 24   | ●                  | ●                         | ●                    | ●                          | ●                         | ●                | 4             |
| REI               | 32   | ●                  | ●                         | ●                    | ●                          | ●                         | ●                | 4             |
| Amazon.com        | 13   | ●                  | ◐                         | ●                    | ●                          | ●                         | ●                | 3             |
| PC Mall           | 27   | ●                  | ◐                         | ●                    | ●                          | ●                         | ●                | 3             |
| Wal-Mart          | 34   | ●                  | ◐                         | ●                    | ●                          | ●                         | ●                | 3             |
| Williams-Sonoma   | 35   | ●                  | ◐                         | ●                    | ○                          | ●                         | ●                | 3             |
| CDW               | 16   | ●                  | ○                         | ○                    | ●                          | ●                         | ●                | 2             |
| Crate & Barrel    | 17   | ●                  | ○                         | ○                    | ○                          | ●                         | ●                | 2             |
| Pottery Barn      | 29   | ●                  | ○                         | ○                    | ○                          | ●                         | ●                | 2             |
| Wine.com          | 36   | ●                  | ○                         | ○                    | ○                          | ●                         | ●                | 2             |
| Crutchfield       | 18   | ●                  | ○                         | ○                    | ○                          | ●                         | ●                | 1             |
| eBay              | 20   | ●                  | ○                         | ○                    | ○                          | ○                         | ○                | 1             |
| Macy's            | 25   | ●                  | ○                         | ○                    | ○                          | ○                         | ○                | 0             |
| Target            | 33   | ●                  | ○                         | ○                    | ○                          | ○                         | ○                | 0             |
| BestBuy.com       | 15   | ◐                  | ○                         | ○                    | ○                          | ○                         | ○                | -1            |
| QVC               | 30   | ●                  | ○                         | ○                    | ○                          | ○                         | ○                | -1            |
| Red Envelope      | 31   | ●                  | ○                         | ○                    | ○                          | ○                         | ○                | -1            |
| 1-800-flowers.com | 12   | ●                  | ○                         | ○                    | ○                          | ○                         | ○                | -2            |
| Finish Line       | 21   | ●                  | ○                         | ○                    | ○                          | ○                         | ○                | -2            |
| MotherNature.com  | 26   | ●                  | ○                         | ○                    | ○                          | ○                         | ○                | -3            |
| The Apple Store   | 14   | ○                  | ○                         | ○                    | ○                          | ○                         | ○                | -4            |

## Key Findings

### The bad

**72%**

...of the sites could not consistently match misspelled search terms with the proper products.

**68%**

...offered minimal or no sorting/filtering options of search result lists..

**64%**

...were unable to consistently match mixed specification searches to valid results.

**56%**

...failed to handle synonyms and related terms at an acceptable level.

**56%**

...provided little or no help on their "No Results Found" pages.

### The good

**92%**

...of the sites presented accurate and relevant results for perfect, error-free searches.

## Breakdown

### Accuracy/Relevance

- 92% Good
- ◐ 8% OK
- 0% Poor

### Misspelled Search Term(s)

- 28% Good
- ◐ 24% OK
- 48% Poor

### Mixed Specifications

- 36% Good
- ◐ 28% OK
- 36% Poor

### Synonyms and Related Terms

- 44% Good
- ◐ 40% OK
- 16% Poor

### Sorting/Filtering Results

- 32% Good
- ◐ 36% OK
- 32% Poor

### No Results Found

- 44% Good
- ◐ 48% OK
- 8% Poor

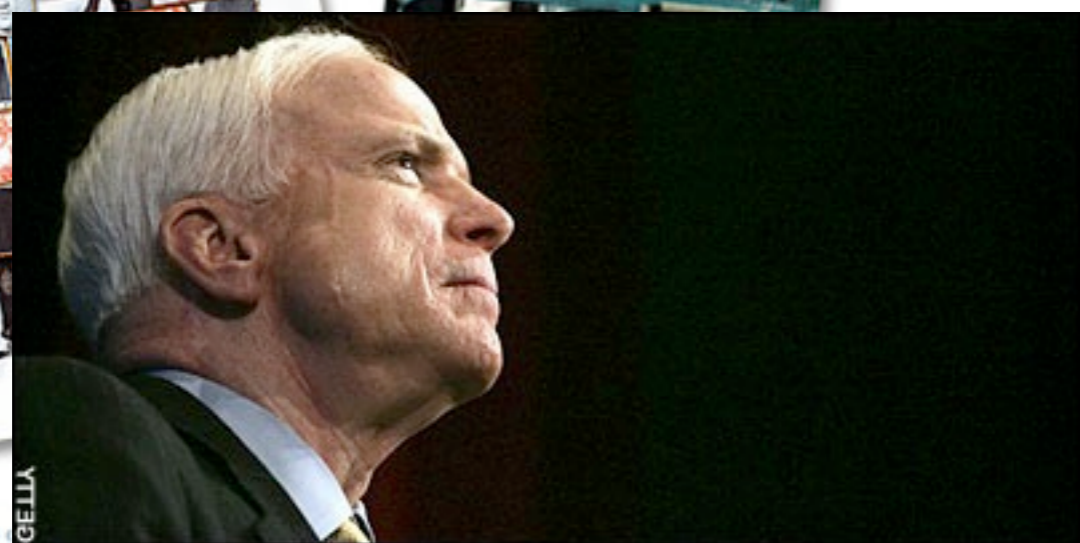

Competencia



**publish**

$$\begin{array}{r}
 5x+3 \\
 x-4 \overline{) 5x^2 - 17x - 12} \\
 \underline{- 5x^2 - 20x} \phantom{- 12} \\
 3x - 12 \\
 \underline{- 3x - 12} \\
 0
 \end{array}$$



because we really munged back by  
**2000**. In step b., **1** is actually **100** so **357**  
 is actually **35,700** etc.

1. Think: How many 300's are in 768? (**2** or **3**?)
2. **549** is the new dividend. How many 300's are in **549**? (**1**?)
3. How many 300's are 1924? Try **5** or **6**. ( $5 \times 357 = \mathbf{1785}$  and  $6 \times 357 = \mathbf{2142}$ .)
4. How many 300's are in **1399**? Try **3** or **4**.  $3 \times 357 = \mathbf{1071}$  and  $4 \times 357 = \mathbf{1428}$ .

Check:  $357 \times \mathbf{2,152} + \mathbf{328} = 768,949$ . Answer can also be written as:  $\mathbf{2153} + \mathbf{328}/357$ . The latter is a mixed number. + is often omitted in mixed numbers.



# Competencia

job interview

- productive
- communicate
- research
- publish

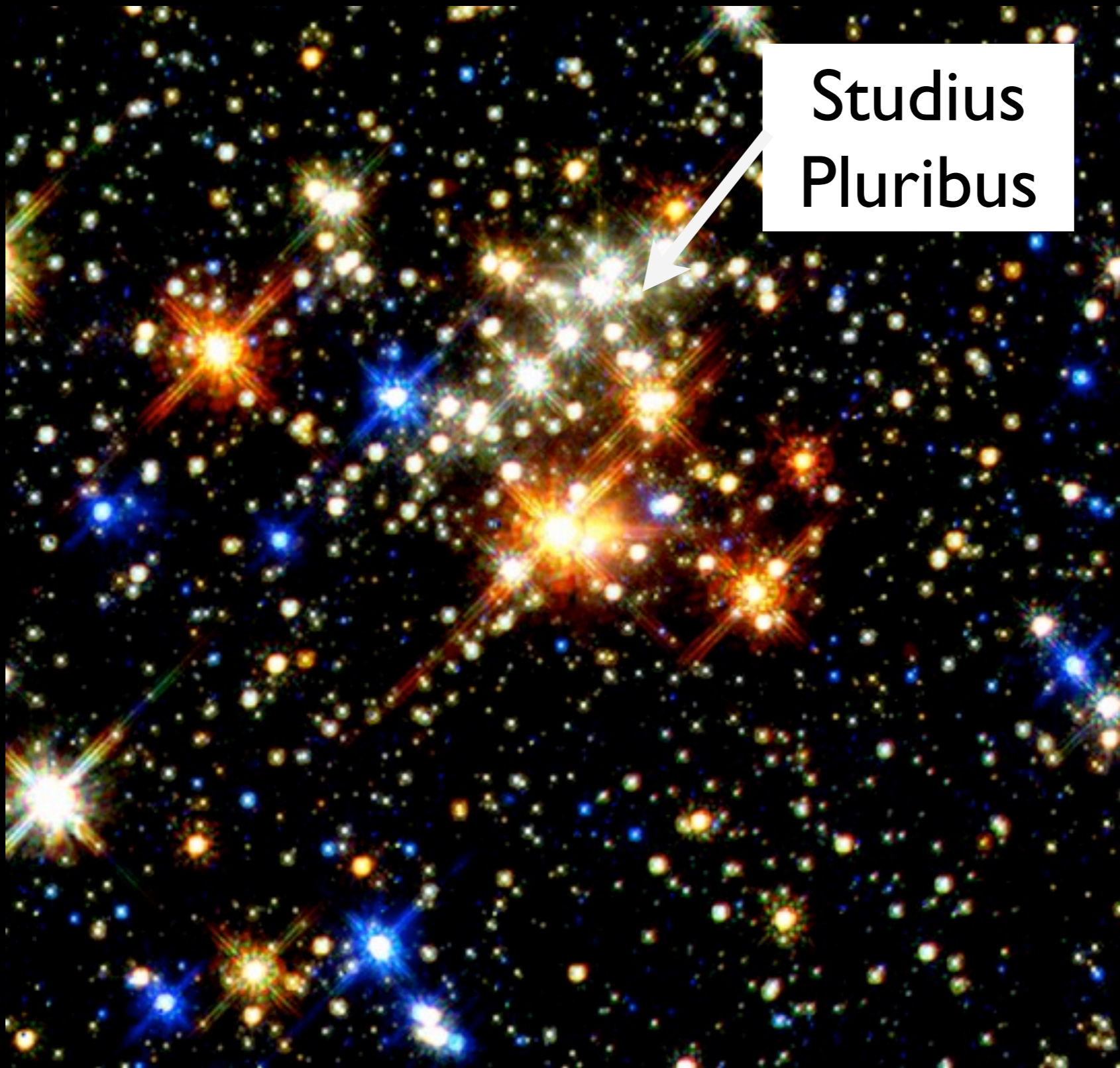

Studius  
Pluribus



Carlo-12

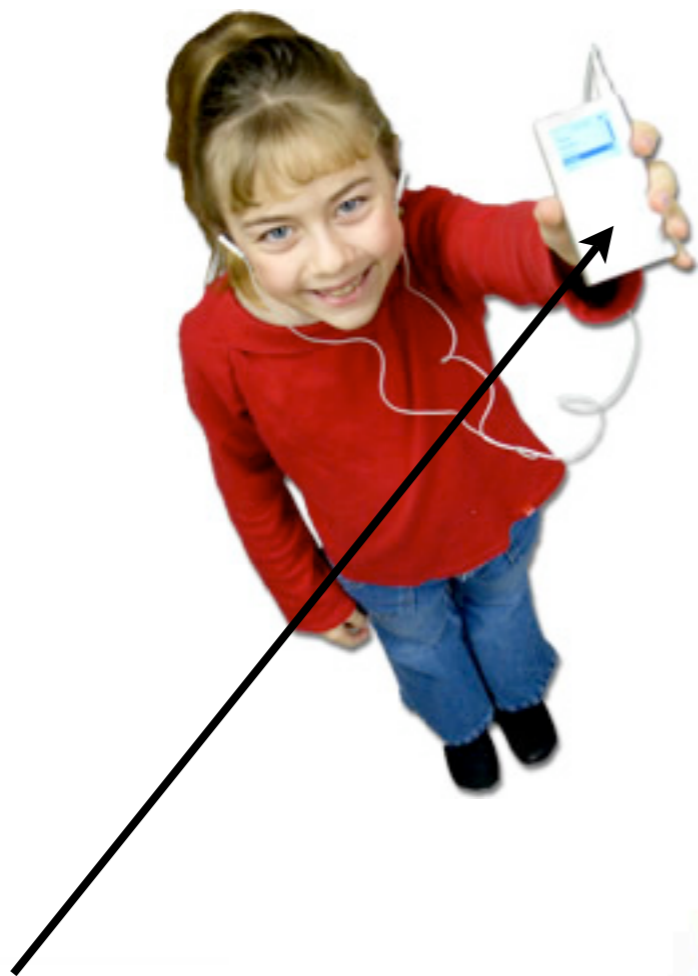



Studius  
Pluribus



**productive**

**alice** [minimize] [maximize] [close]

File Action View Help

- ▼ **Support (3/3)**
  - ◆ bob
  - ◆ peter
  - ⬢ mark (meeting)
- ▶ **Engineering (1/2)**
- ▼ **Sales (1/2)**
  - ◆ carol
- ▼ **Offline (2/7)**
  - eliza
  - ◆ mallory (business)

active ■

Notifications Received by mark

File Edit Action View Help

| Sender | Date                      | Subject |
|--------|---------------------------|---------|
| bob    | 10:05 PM, Thu 2001/1/1/02 | Ph...   |
| alice  | 10:38 PM, Thu 2001/1/1/02 | Sel...  |

From: bob  
To: alice, den

Please review the sales report  
1 PM, Thu 2001/1/1/02

view last week's sales report before

Conference started by bob

File Edit Compose Conference

Conference started by bob on Fri Feb 21 09:06:43 2003 (alice True)

bob: Hi, This is Bob. This meeting is the meeting to decide when we are going to have a meeting.

alice: Hi, Bob

eve: Wait, any time it fits with me. Bye.

alice: Same here.

eve has left the conference

bob: Let's make it tomorrow at eleven then.

Active (2/7)

- bob
- alice

Inactive (1/3)

- eve (left)

Absent (1)

- den (no-reply)

Also take a look at **Mary Johnson's** resume. Note that she has **four** year of Python experience, so hopefully she may be what we are looking for.

Chat with Matt

3:39 PM

Hi Matt

Encryption with Bob has been enabled.

Hi Bob

Those files for the Axis account ready?

Yes, have them right here.

Great! Send 'em on over.

Axis\_financials.pages

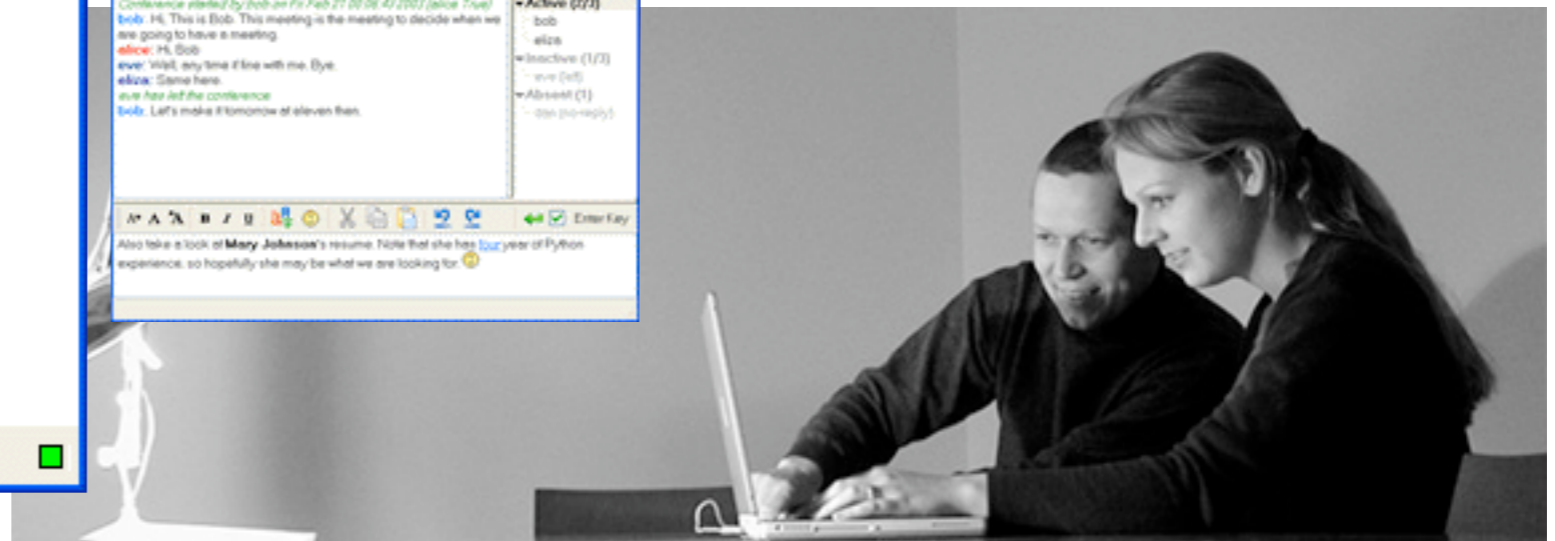



Studius  
Pluribus



**communicate**

Navigation icons: back, forward, refresh, home, search.

Address bar: <http://www>

Bookmarks: Get There, NCER Fundin...Technology

Menu: Cars, Auto Financing, Event Tickets, Jobs

Search bar with "Search" button.

## Best Rated TVs from Consumer Reports

### Over 110 television models tested. Which are top-rated?

From tech updates to new trends (including 1080p full resolution and LED backlights), **ConsumerReports.org** gives you test results with all the information you need when buying a new TV.



- ▶ What type: HDTV, LCD, Plasma, Picture Tube, Rear Projection, Front projector
- ▶ Image quality
- ▶ Screen size
- ▶ Screen shape
- ▶ Connections
- ▶ Features

For our complete television Ratings and Reviews, including our comprehensive **TV Decision Guide**...

#### Tested Television Brands

- ▶ Akai
- ▶ Audiovox
- ▶ Hewlett Packard
- ▶ Hitachi
- ▶ JVC
- ▶ LG
- ▶ Magnavox
- ▶ Mitsubishi
- ▶ Olevia
- ▶ Panasonic
- ▶ Phillips
- ▶ Pioneer
- ▶ RCA
- ▶ Samsung
- ▶ Sanyo
- ▶ Sharp
- ▶ SONY
- ▶ Toshiba
- ▶ Westinghouse
- ▶ Vizio



Home News T

Sports Fantasy MLB NFL NBA

02/12/2008 - 6:15 AM - Click reload often for latest version

## Monday's scores

Scores pages refresh every two minutes

NBA, NHL, NCAA, NCAAW, PGA Tour, Championship

### See a Celeb?

COLLEGE HOME GET STARTED FIND A SCHOOL PREPARE FOR TESTS PAY FOR SCHOOL

#### MY PETERSON'S LOGIN

[What is My Peterson's?](#)

Enter Username

[Forgot Username/Password?](#)

[New User? Register Now!](#)

[Overview](#) | [Planning Timelines](#) | [Build Your Credentials](#) | [Find Your Champions](#) | [Admission Essay](#)  
[College Consulting](#) | [Using My Peterson's](#) | [Advice Center](#)

colleges&universities  
bestcollegepicks

Your cookies are disabled. Please enable your cookies so you can use our online services. After enabling cookies, refresh your page to continue.  
[More Information](#)

Already Registered?

login

User Name:

Password:





e.g., "10 market st, san francisco" or "hotels near lax"

Search input field: howard beach, new york

Search Maps

Show search options

Search the map

Find businesses

Get directions

Search Results

My Maps

Print, Send, Link to this page

### Howard Beach, NY

Make this my default location

#### Popular searches near this location

- [subway station](#)
- [map quest](#)
- [car service](#)
- [laguardia airport](#)
- [lirr](#)
- [elmhurst hospital](#)
- [new york hall of science: administration](#)
- [st johns university](#)
- [flushing meadow park](#)

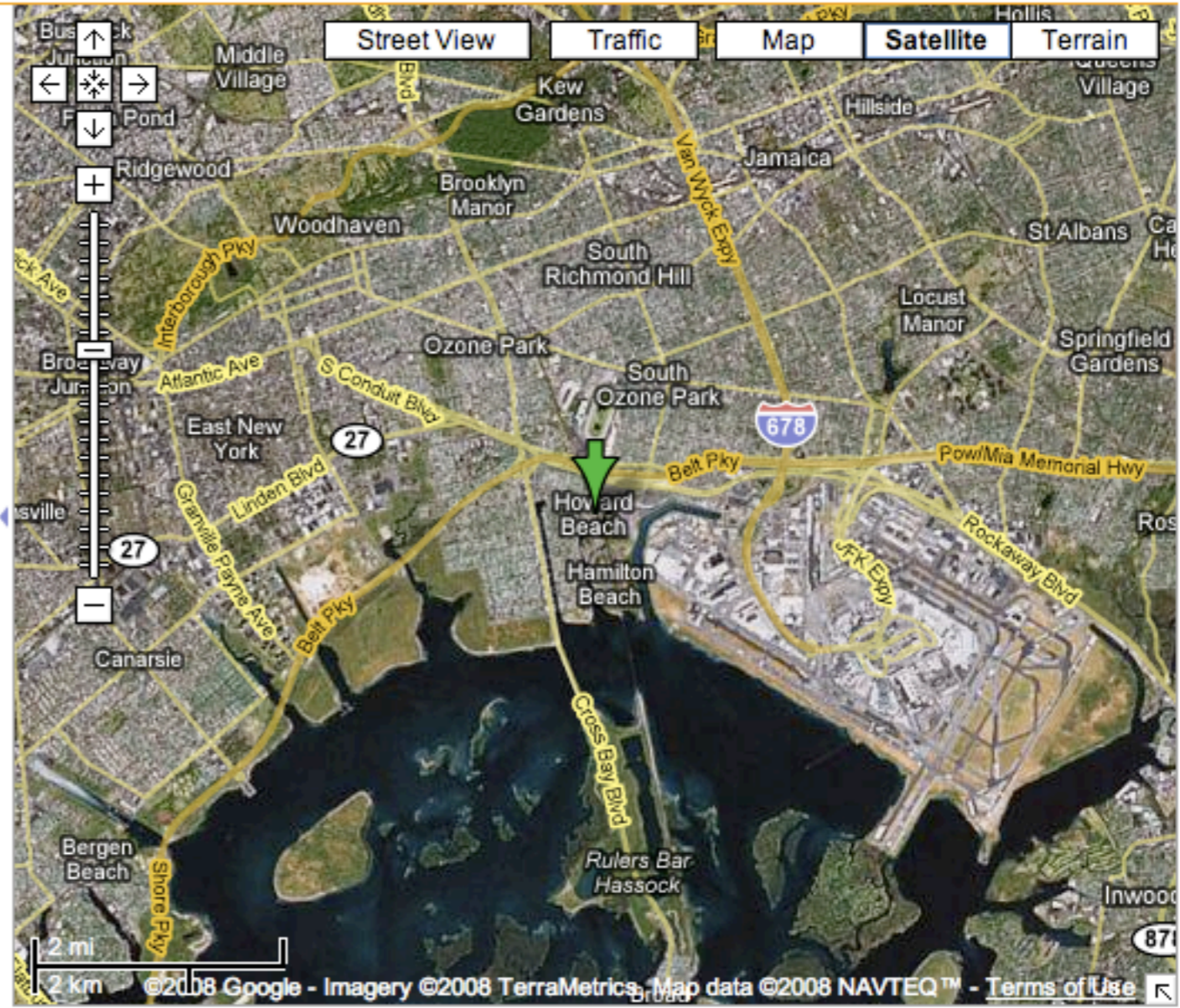

Studius  
Pluribus



research





Studius  
Pluribus



media



Studius  
Pluribus



**publish**

Studius  
Pluribus



Technis  
Major



Competencia



**You** **Tube**

Broadcast Yourself



Studius  
Pluribus



Technis  
Major



Competencia



productivity

communication

research

publishing



# Studios Pluribus

a day in the life

- productive
- communicate
- research
- publish

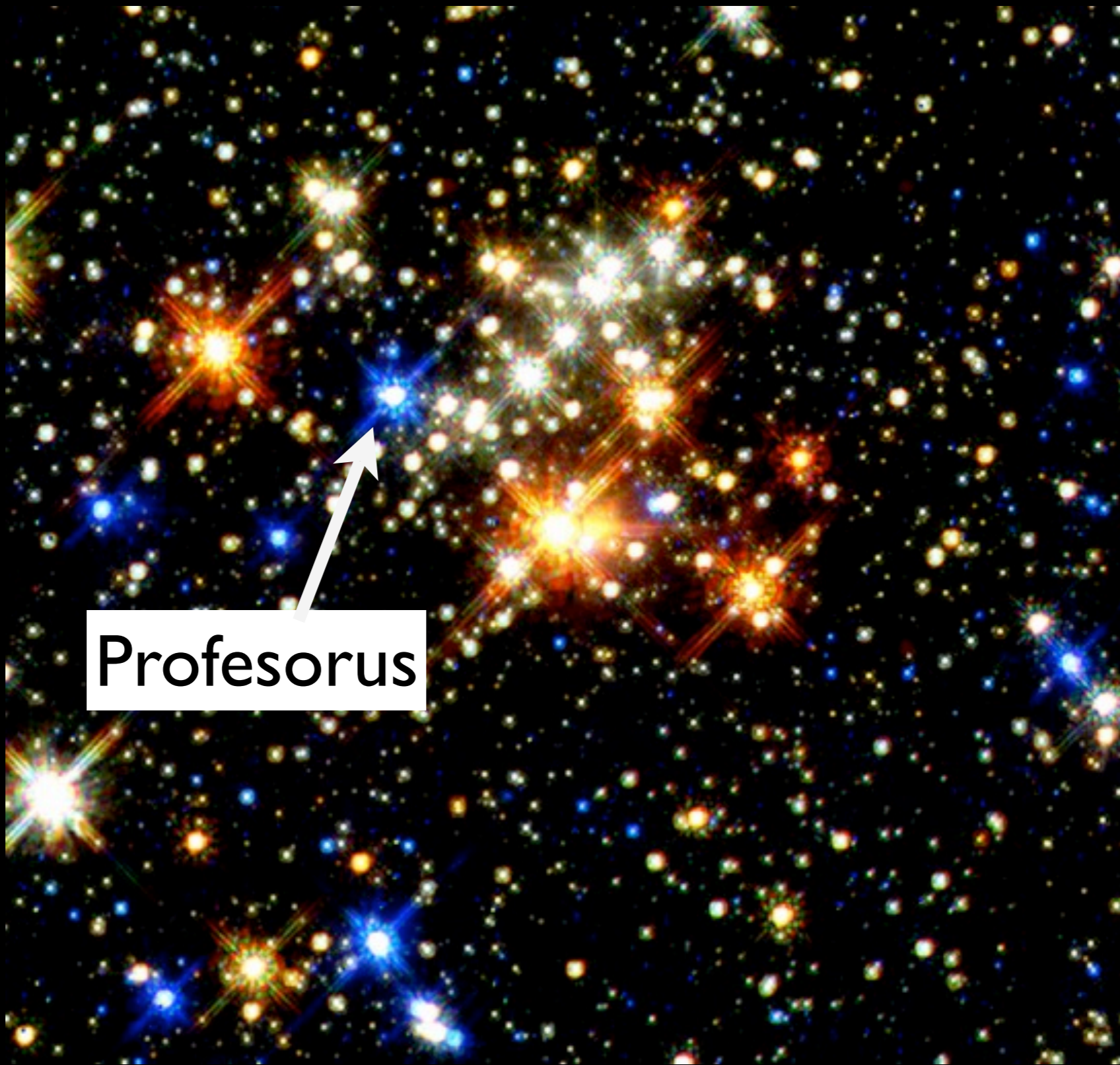

Profesorus

Studius  
Pluribus



Technis  
Major



Competencia



Studius  
Pluribus



Technis  
Major



Profesorus



Competencia





n of the Cemetery at Gettysburg, Pennsylvania]

the founders of our nation (established) in North America a  
nization], that entertained ideas of freedom, while at the same  
of equality. The armed military conflict in which we find  
difficult for this country to handle.

2/12/08 2:09 PM

**Comment:** Let me suggest a more succinct title, something short and sweet that people will remember.

2/12/08 2:19 PM

**Comment:** Avoid starting a sentence with a number. It lacks drama. Consider the biblical span of a man's life, three-score and ten, and build from there.

2/12/08 2:19 PM

**Comment:** This is a weak verb. Consider something more natural and active.

2/12/08 2:13 PM

**Comment:** Why use three words when one would do? Consider *nation*, or *country* here.

# productive

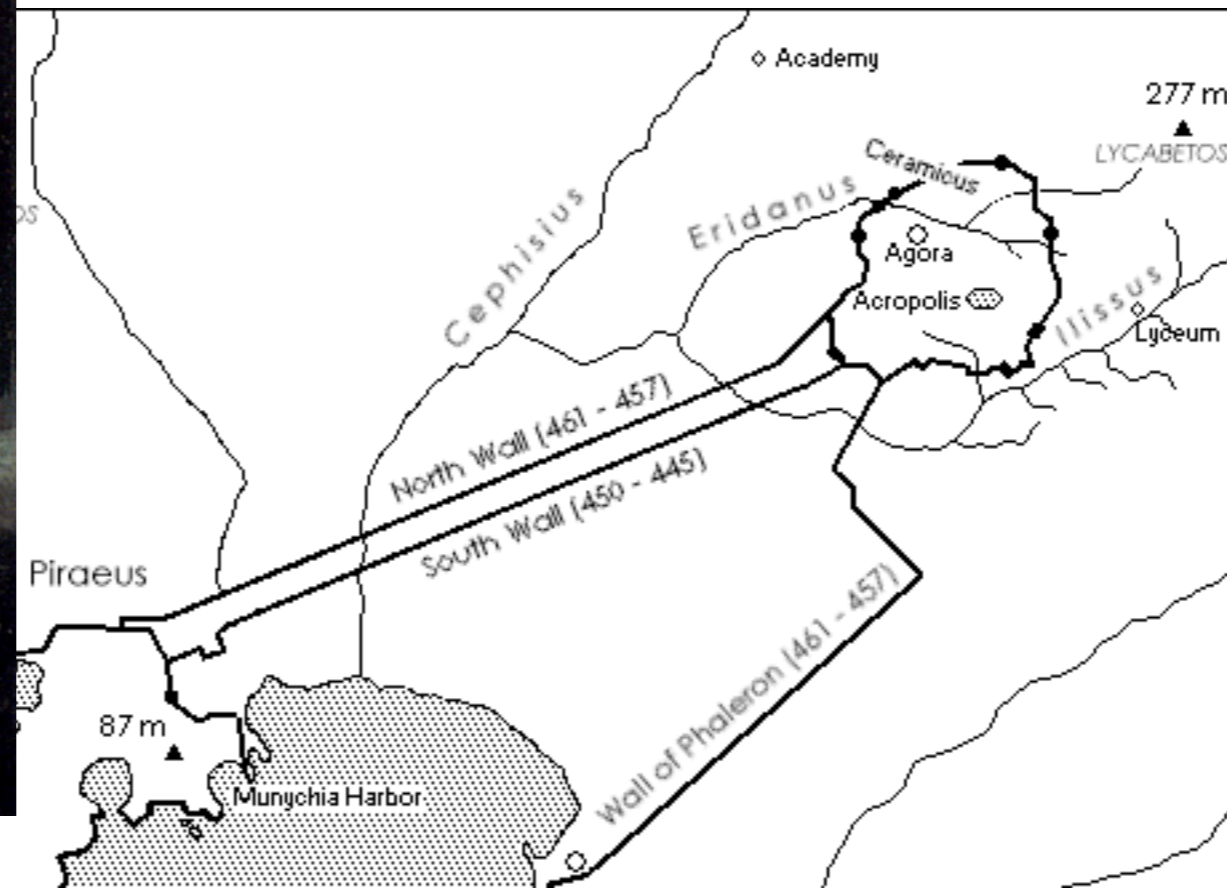



communicate

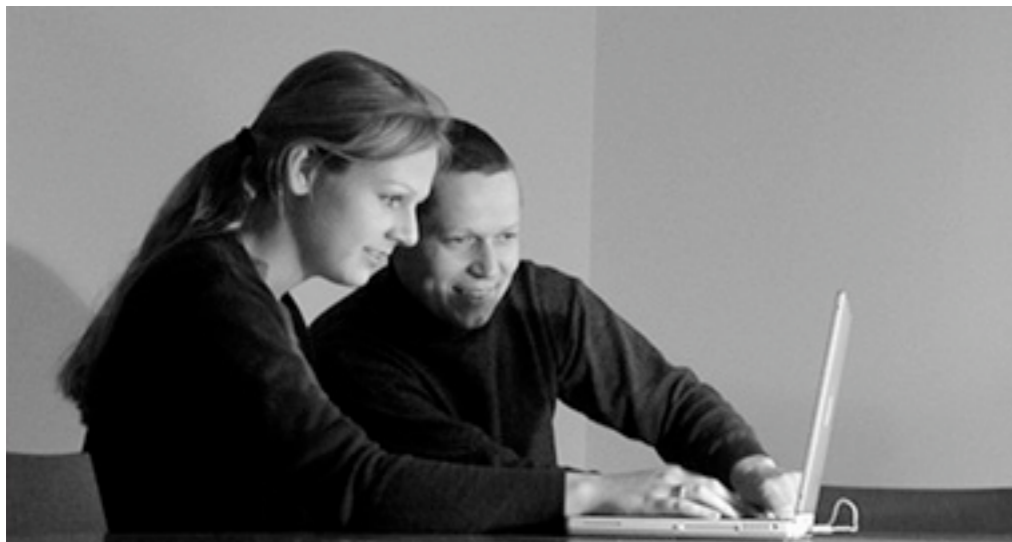

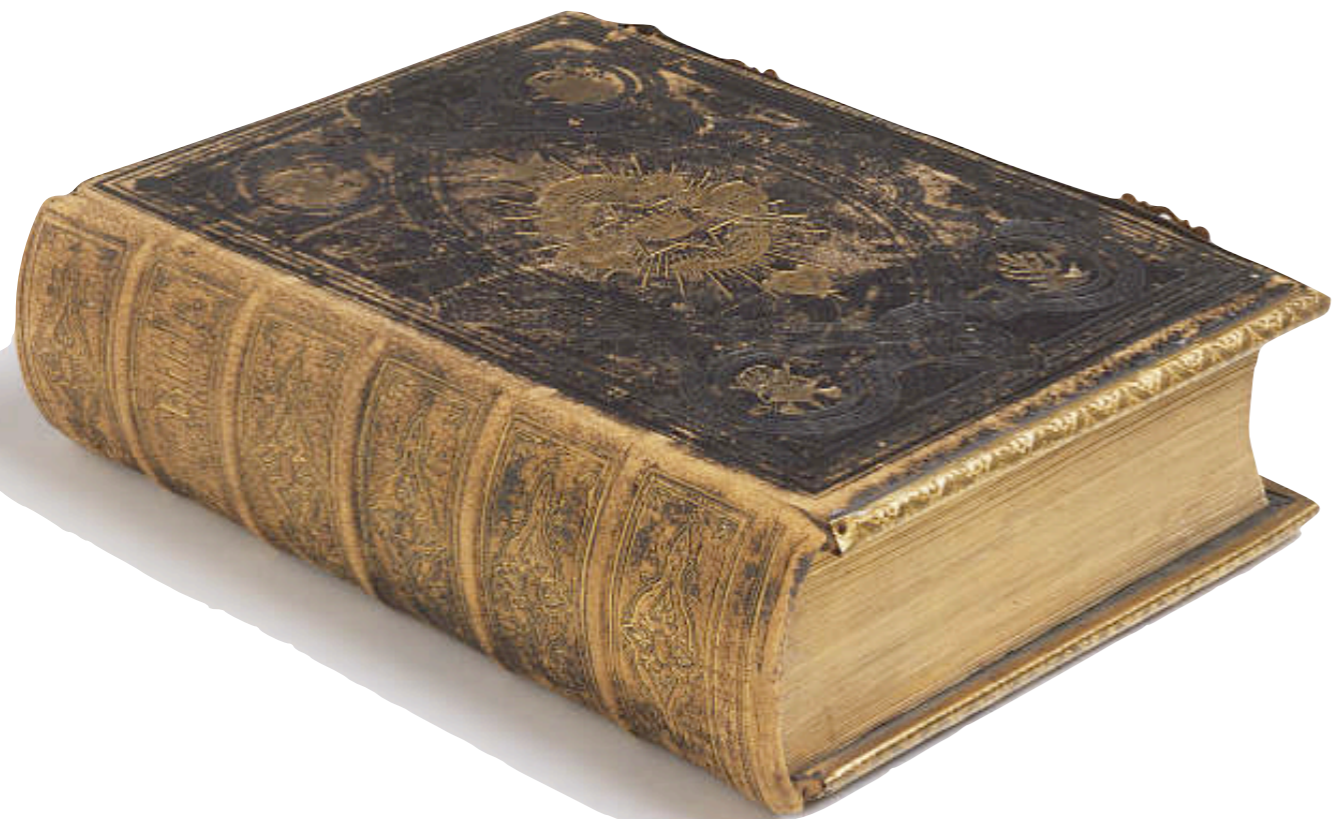

research



# research

Le Monde.fr : A la une

http://www.lemonde.fr/ RSS Google

Get There NCER Fundin... Technology QuickTime S...er.cuny.edu Small Busine...IR) Program Apple Yahoo! Google Maps YouTube Wikipedia News

**Le Monde.fr**  
Mise à jour à 15 h 31 - Paris

Recherchez depuis 1 mois

sur Le Monde.fr sur le web avec YAHOO! SEARCH

» Recevez les newsletters gratuites » Abonnez-vous au journal Le Monde : 16€/mois

**FORTUNEO**

Identifiez-vous  
email  
Mot de passe  
mémorisez | oublié?

actualités perspectives pratique annonces le desk le kiosque newsletters multimédia références EDITION ABONNES Abonnez-vous 6€ Mercredi 13 février 2008

**Le Monde.fr**  
Faire-part

**Vous aussi, déclarez votre flamme en Une du Monde.fr !**

Offre spéciale **10 €** Cliquez ici seulement

**Les Occidentaux face à l'imminence d'une indépendance du Kosovo**

Les Etats-Unis et les grands pays européens prêts à reconnaître rapidement le Kosovo indépendant (France, Royaume-Uni, Allemagne et Italie) procéderaient de façon concertée, si ce n'est quasi simultanée.

**Chronologie** Le Kosovo à la recherche d'un nouveau statut



**LES DÉPÊCHES**

- Grève dans l'audiovisuel public, une première depuis 1974 Reuters 15h28
- Un militaire italien tué près de Kaboul Reuters 14h55
- Le gouvernement veut accélérer l'application des lois en France Reuters 14h49
- Un chef recherché du Hezbollah tué par une bombe à Damas Reuters 14h21

Toutes les dépêches

**EN DIRECT**

**Chat à 15 heures**  
Peut-on réguler le capitalisme financier ? Débat en direct avec Jérôme Creel, professeur à l'ESCP-EAP, directeur adjoint du département des études de l'OFCE, centre de recherche en économie de Sciences Po, en partenariat avec l'OFCE mercredi 13 février 2008 à 15 h 00, mercredi 13 février 2008 à 15 h 00



**Chat jeudi à 11 h 15** "Les politiques en direct" - Invité : Jean-Pierre Raffarin

PUBLICITE

**Le 4 mars, prochain grand rendez-vous des primaires américaines**

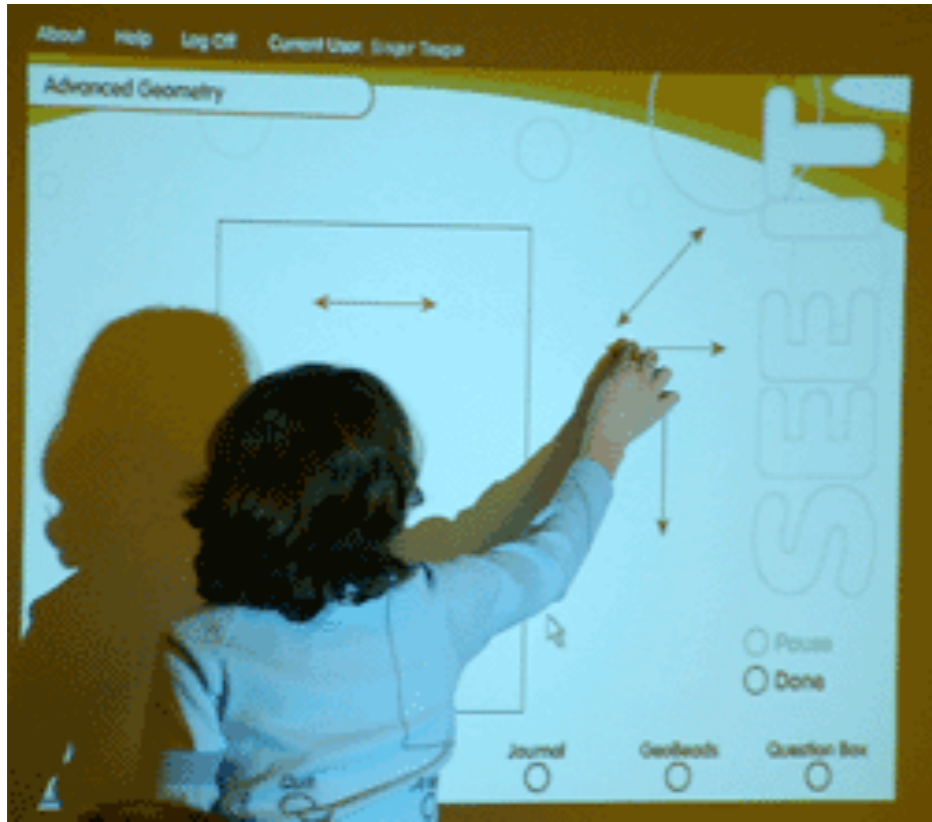

media



## Image Influence Impact

Techniques of legal  
control: censor  
chill, contempt  
sundry other

publish

Studios  
Pluribus



Technis  
Major



Competencia



Profesorus



# Image Influence Impact

Techniques of  
control: censor  
chill, contempt  
and  
sundry other





# Profesorus

how digital are they?

- productivity
- communication
- research
- publishing

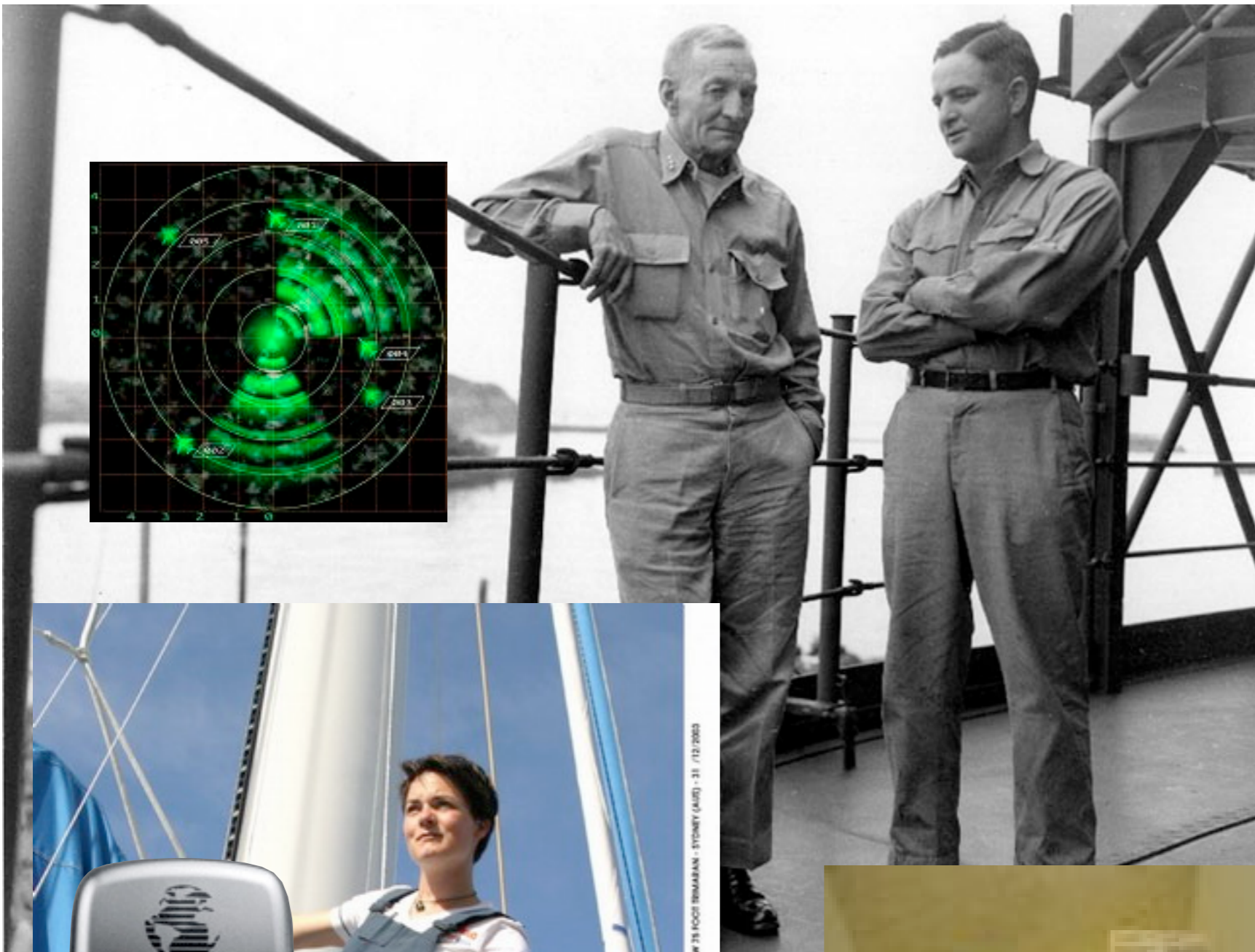

SAILING - CASTORAMA IMG / SKIPPER : ELLEN MACARTHUR (USA) - ELLEN ON BOARD OF HER NEW 75 FOOT TRIMARAN - SYDNEY (AUS) - 31 /12/2003  
PHOTO : ANDREA FRACOLINI / DDPY / OFFSHORE CHALLENGES

: J.S. M

